



SimpliPhi Power PHI Battery

INTEGRATION GUIDE: SOL-ARK

Optimized Energy Storage & Management for Residential & Commercial Applications Utilizing Efficient, Safe, Non-Toxic, Energy Dense Lithium Ferrous Phosphate (LFP) Chemistry

TABLE OF CONTENTS

1. INTRODUCTION	2
2. PHI BATTERY BANK-TO-INVERTER CONNECTION	3
3. BATTERY BANK SIZING	4
Discharge Calculation: Inverter Power Bank Sizing	4
Charge Calculation: AC Coupled Systems	5
Charge Calculation: DC Coupled Systems	5
4. PROGRAM SETTINGS FOR PHI BATTERIES	6
Depth of Discharge	6
Inverter and Charger Settings	7
Grid Setup	10
5. USE CASES & APPLICATION NOTES	12
AC Coupled	13
Grid Sell / Grid-Tied with Battery Backup	14
Limited to Home	14
Limited to Load	15
Time of Use / Energy Arbitrage	16
Off-Grid	17
Generators	17
Smart Load	18
6. SPECIFICATIONS & WARRANTY	19
7. SIMPLIPHI TECHNICAL SUPPORT	19

1. INTRODUCTION

This integration guide covers the recommended set up and configuration of Sol-Ark equipment for optimizing performance with SimpliPhi's 51.2V_{nominal}-model PHI batteries.



CAUTION: Pairing 48 Volt-rated inverters (such as the Sol-Ark-8K or Sol-Ark-12K) with batteries other than those rated at 51.2V_{nom} voids the PHI Battery Warranty.

More information on SimpliPhi products can be found on our website at <https://simpliphipower.com/>. All SimpliPhi Product Documentation can be found at <https://simpliphipower.com/product-documentation/>. More information regarding Sol-Ark's products can be found at <https://www.sol-ark.com>.

The Sol-Ark products covered in this guide are the [Sol-Ark-8K-48-ST](#) and the Sol-Ark-12K-P. Limiter sensors and the critical loads sub-panel referenced in this Guide are included with a purchase of Sol-Ark equipment.

Contact SimpliPhi Power Technical Support (805-640-6700; techsupport@simpliphipower.com) regarding any compatibility questions for products not listed in this guide.

2. PHI BATTERY BANK-TO-INVERTER CONNECTION

Wire the PHI Battery bank to the Sol-Ark according to the [PHI Battery Installation Manual](#), not according to the Sol-Ark Manual:

Figure 1 - Sol-Ark to Battery Connection

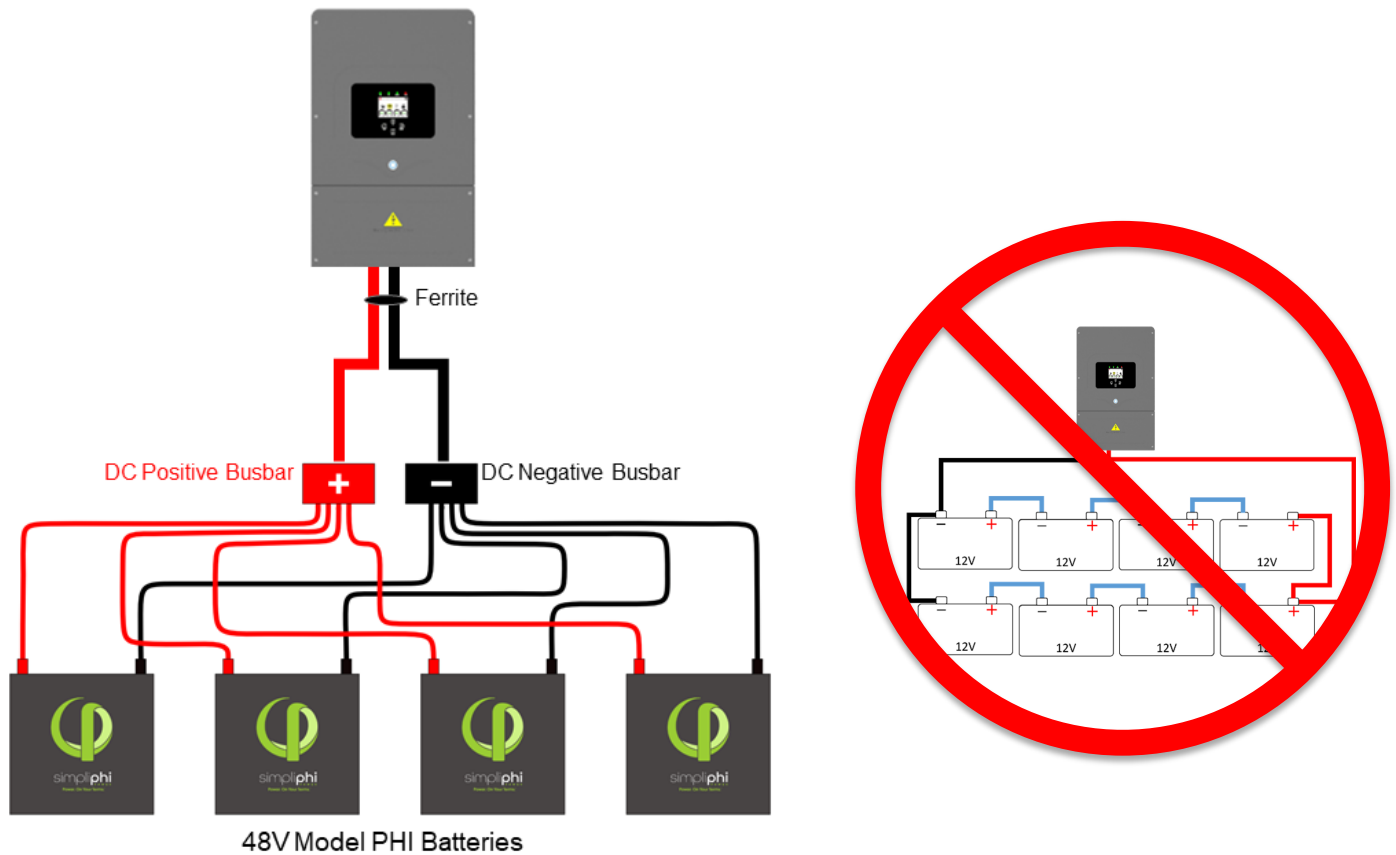

It is acceptable but not required to use the ferrite choke on the positive and negative DC busbar-to-inverter leads (see Figure 1 above).

SimpliPhi and Sol-Ark recommend **against** using the 100 Ohm resistor included with the Sol-Ark equipment to charge the Sol-Ark's capacitors when connecting the PHI Batteries for the first time (as described in the [Sol-Ark Install Guide Owner's Manual](#)).

Do not install the Battery Temperature Sensor. The PHI Batteries require no temperature compensation.

3. BATTERY BANK SIZING

A properly sized PHI battery bank is sized to prevent over-discharge and over-charge from accompanying equipment. While the programming features of the Sol-Ark allow for battery discharging and charging according to specifically set parameters (refer to Section 4 of this Guide), the Sol-Ark does not limit the batteries' maximum discharge current (**Max A Discharge**) in an off-grid or grid-failure scenario.

Therefore, the PHI battery bank should still be sized to protect against over-discharge. In the case of an AC Coupled system setup, the PHI battery bank should also be sized to protect against over-charge from the solar photovoltaic (PV) array. In a DC Coupled system, the PHI battery bank's charge rate can be limited via Sol-Ark equipment programming (**Max A Charge**). When sizing the PHI battery bank according to both the discharge and charge criteria, use the greater of the two calculation results as the minimum quantity of PHI batteries in the bank.

Discharge Calculation: Inverter Power Bank Sizing

To protect against over-discharge (voiding the battery Warranty), the PHI battery bank should be sized so that the inverter's load rate does not exceed the batteries' maximum continuous discharge rate.

The discharge calculation uses the nomenclature below:

- Battery maximum continuous discharge rate (kW_{DC}) = Bat_{kW} (typically @ C/2)
= (maximum battery discharge current × battery voltage nominal)
- Inverter power full load ("load rate") = Inv_{kW}
- Inverter DC-to-AC efficiency = Inv_{eff}

$$\text{Discharge Example: } B_{\#Inv} \geq \frac{Inv_{kW} \div Inv_{eff}}{Bat_{kW}}$$

- Sol-Ark-8K inverter is rated at 8 kW
 - Depending on the Sol-Ark's mode of operation (refer to Section 5 of this Guide), the inverter may power only loads on the critical loads sub-panel or it might power loads both on the critical loads sub-panel and the main house breaker panel. Consider the inverter's mode when sizing the battery bank according to "load rate."
- Sol-Ark-8K inverter DC-to-AC efficiency is 95.5%
- PHI 3.8 kWh-51.2V_{nom} battery has a maximum continuous discharge rate of 1.92 kW_{DC}

$$B_{\#Inv} \geq \frac{8_{kW} \div 0.955_{eff}}{1.92_{kW}} = 4.4$$

A properly sized PHI battery bank based on the maximum discharge of the inverter, or load rate, has a minimum of 5 batteries. This ensures that the battery bank does not over-discharge to power the loads. Refer to this Section 5 of this Guide to verify battery bank sizing in specific use cases.

Charge Calculation: AC Coupled Systems

To protect against over-charge (voiding the battery Warranty), the PHI battery bank should be sized so that the AC Coupled solar PV array's power output does not exceed the batteries' maximum continuous charge rate. In an AC Coupled system, significantly limiting the solar array's charging power does not work well. Therefore, SimpliPhi and Sol-Ark recommend sizing a larger battery bank relative to the AC Coupled PV array. Specifically, multiply the batteries' typical maximum continuous charge rate by a de-rate factor of **0.8** in this AC Coupled scenario.

The charge calculation uses the nomenclature below:

- Battery maximum continuous charge rate (kW_{DC}) = Bat_{kW} (typically @ C/2)
= (maximum battery charge current × battery voltage nominal)
- PV charge maximum = PV_{kW}

$$\text{Charge Example: } B_{\#PV} \geq \frac{PV_{kW}}{0.8 \times Bat_{kW}}$$

- AC Coupled Solar PV Array is rated at 8 kW
- PHI 3.8 kWh-51.2V_{nom} battery has a maximum continuous charge rate of 1.92 kW_{DC}

$$B_{\#PV} \geq \frac{8_{kW}}{0.8 \times 1.92_{kW}} = 5.2$$

A properly sized PHI battery bank based on the maximum charge from the AC Coupled solar PV array has a **minimum of 6 batteries**. This ensures that the battery bank does not over-charge from the AC Coupled solar PV.

When comparing the same system using both the discharge and charge calculations for sizing the PHI battery bank, the minimum number of batteries in the bank should be the greater of the two results. For instance, when examining the discharge calculation in the above example and the charge calculation in this AC Coupled example, 6 batteries should be used in the system.



CAUTION: Using fewer than the calculated number of PHI batteries in this AC Coupled charge calculation will void your PHI Battery Warranty. If a smaller PHI battery bank must be used, then the amount of AC Coupled solar PV in the battery-based system must also be reduced accordingly, and any excess solar must be wired to a separate system.

Charge Calculation: DC Coupled Systems

While the PHI battery bank's charge rate in a DC Coupled system can be limited via Sol-Ark programming (**Max A Charge**), consider the PHI battery bank's maximum continuous charge rate in the system's design.

The charge calculation uses the nomenclature below:

- Battery maximum continuous charge rate (kW_{DC}) = Bat_{kW} (typically @ C/2)
= (maximum battery charge current × battery voltage nominal)
- PV charge maximum = PV_{kW}
- Sol-Ark PV-to-Battery efficiency = Inv_{eff}

Charge Example: $B_{\#PV} \geq \frac{PV_{kW} \times Inv_{eff}}{Bat_{kW}}$

- DC Coupled Solar PV Array is rated at 8 kW
- Sol-Ark PV-to-Battery efficiency is 97.5%
- PHI 3.8 kWh-51.2V_{nom} battery has a maximum continuous charge rate of 1.92 kW_{DC}

$$B_{\#PV} \geq \frac{8_{kW} \times 0.975_{eff}}{1.92_{kW}} = 4.06$$

A PHI battery bank utilizing the entire DC Coupled solar PV output potential has 5 batteries. However, programming the **Max A Charge** in the Sol-Ark to 150 A (4 × 37.5 ADC) would prevent the over-charging of a battery bank that includes only 4 batteries (refer to Section 4 of this Guide for complete programming details).

Homeowners with little to no loads on during the day (while solar power production is at its peak) might consider sizing a larger PHI battery bank to take advantage of the entire solar PV output potential for battery charging. Homeowners that consistently power loads during peak solar power production times may require a smaller sized battery bank.

4. PROGRAM SETTINGS FOR PHI BATTERIES

In order to maintain the PHI Battery Warranty, it is critical that the appropriate settings for the desired Warranty level are programmed in all system components. Failure to program the settings as described in this Guide will void your Battery Warranty.

Depth of Discharge

To optimize the PHI batteries' and overall system's performance and life, SimpliPhi Power recommends programming the equipment settings for an 80% maximum Depth of Discharge (DoD). Maintaining the PHI battery at this DoD qualifies it for the 10-year / 10,000 cycle Warranty level. SimpliPhi warranties the PHI battery for fewer cycles at greater DoD levels: 90% DoD is correlated with a 5,000-cycle Warranty and 100% DoD correlates with a 3,500-cycle Warranty.



CAUTION: If a firmware update is executed on the Sol-Ark equipment, **ALL** the settings must be reverified. The programmed settings shown in the following tables must be applied based on desired Warranty/Cycle life. The recommended is 80% Depth of Discharge.

Inverter and Charger Settings

Refer to Sol-Ark's **Menus and Programming** online video (<https://www.youtube.com/watch?v=mcXXzgfRT90&t=1497s>) for guidance on programming the settings outlined in Table 1 below.

Press the gear icon to get to the **Settings** menu (Figure 2), then press **Battery Setup** (Figure 3) to program the parameters in Table 1 below.

Figure 2 – Sol-Ark Home Screen (Touchscreen), from the Sol-Ark Installation Manual

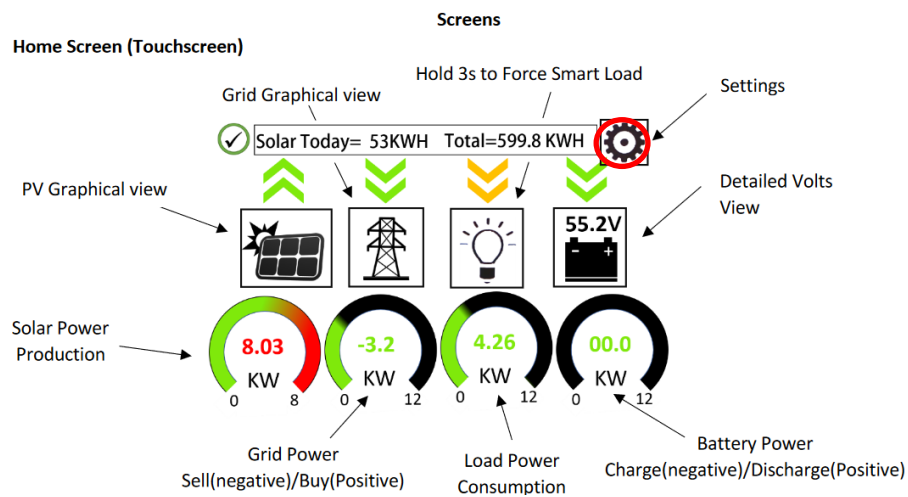

Figure 3 – Sol-Ark System Setup Screen, from the Sol-Ark Installation Manual

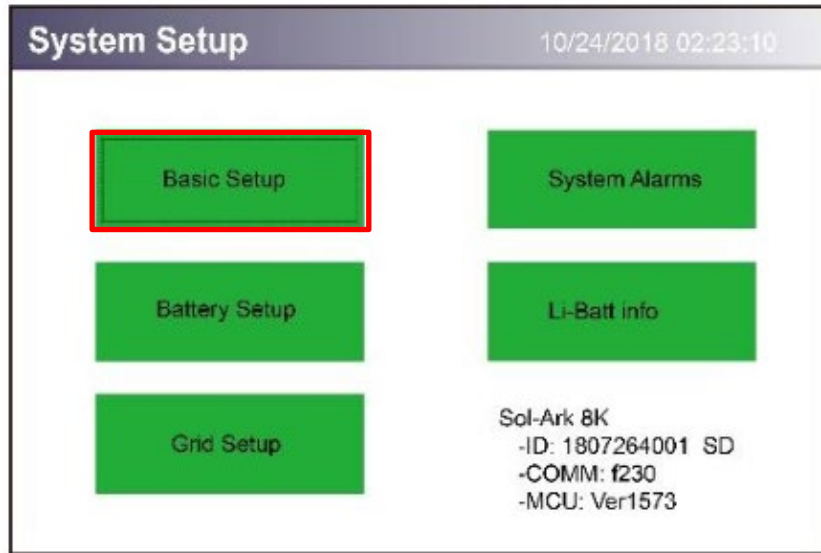

Table 1 – Sol-Ark Battery Settings for 51.2V_{nom} PHI Battery Models

System Setup > Battery Setup	80% DoD (10k cycle warranty)	90% DoD (5k cycle warranty)	100% DoD (3.5k cycle warranty)
> Batt Tab			
Batt Capacity	75 Ah per PHI 3.8 battery		
	57 Ah per PHI 2.9-51.2 battery		
Max A Charge ^{1,2}	37.5 ADC per PHI 3.8 battery (20 ADC per battery for reduced stress)		
Max A Discharge ¹	37.5 ADC per PHI 3.8 battery		
TEMPCO	0 mv/C/Cell (disabled)		
Use Batt V Charged	do not check this box		
Use Batt % Charged	check this box		
No Battery	do not check this box		
BMS Lithium Batt	do not check this box		
Activate Battery	do not check this box		
> Charge Tab	80% DoD	90% DoD	100% DoD

Start V	Use Start % instead of Start V when using Batt % Charged instead of Batt V Charged (in the Batt tab)		
Start % ³	21%	11%	1%
A ¹⁴	37.5 ADC per PHI 3.8 battery (20 ADC per battery for reduced stress)		
Gen Charge / Grid Charge ⁵	Check the Gen Charge box when a generator is connected to the Gen Input breaker.		
	Check the Grid Charge box when a generator is connected to the Grid Input breaker, or when a grid connection is utilized to charge the batteries.		
Float V	54 V		
Absorption V ⁶	56 V		
Equalization V ⁷	56 V		
	30 days		
	1 hour		
> Discharge Tab	80% DoD (recommended)	90% DoD	100% DoD
Shutdown	20% (50.2 V)	10% (49.5 V)	0% (48 V)
Low Batt	30% (50.5 V)	20% (50.2 V)	10% (49.5 V)
Restart	97% (52 V)	97% (52 V)	97% (52 V)
Batt Resistance	Resistance mOhms = $96 \div (4 \times \text{PHI 3.8 battery quantity})$		
	Resistance mOhms = $96 \div (3 \times \text{PHI 2.9 battery quantity})$		
Batt Charge Efficiency	99%		
> Smart Load Tab			
Use Gen input as load output	check this box if the Smart Load feature applies (refer to Section 5 of this Guide)		
Smart Load OFF Batt ⁸	95% (51.7 V)		
Smart Load ON Batt ⁹	100% (52.5 V)		
	Wattage value is used in grid-connected systems only. This value represents the minimum power required of the solar array before the Smart Loads are powered.		
For Micro inverter input	check this box for AC coupled systems		
Smart Load OFF Batt ¹⁰	100% (52.5 V)		
Smart Load ON Batt ¹¹	30 – 95%		

Notes:

1. These settings are calculated by multiplying the per-battery value by the number of batteries in the connected battery bank.
2. **Max A Charge** refers to the maximum charge rate from the solar PV array. Programming this value to the maximum value versus the reduced-stress value does not impact the PHI Battery Warranty.
3. If the Auto Generator Start is utilized, the AGS is triggered when the batteries reach this set State of Charge (SoC) percentage. Once triggered, the generator charges the batteries until they reach approximately 95% SoC, at which point the generator turns off. This 95% SoC parameter is not programmable.
4. **A** refers to the maximum charge rate from the grid or the generator. If the Sol-Ark is connected to both the grid and a standby generator, the Sol-Ark prioritizes the grid as the batteries' charging source. Programming the **A** value to the maximum value versus the reduced-stress value does not impact the PHI Battery Warranty.
5. By default, battery charging from the solar PV array is prioritized over generator or grid charging.
6. When the battery has reached the Absorption voltage setpoint, the Sol-Ark utilizes constant-voltage regulation to maintain the battery at the programmed Absorption voltage. The Absorption phase lasts until the batteries charge at 2% of the programmed Ah size. For example, one PHI 3.8-51.2V_{nom} battery (rated at 75 Ah), will remain in the Absorption charging phase until the number of Amps used to charge the battery decreases to 1.5 Amps DC (2% of 75Ah).
7. While the PHI Battery does not require an Equalization charge, programming Equalization to the voltage, frequency and duration outlined in the table above ensures that the Sol-Ark's internal SoC meter re-sets to 100% SoC every 30 days.
8. Smart Loads are no longer powered via solar and/or batteries when the batteries' SoC level drops below this programmed **Smart Load OFF Batt** value.
9. Smart Loads are powered via solar and/or batteries when the batteries' SoC level exceeds this programmed **Smart Load ON Batt** value.
10. The Sol-Ark stops charging the batteries and powering the loads from the AC Coupled solar PV array once the batteries' SoC level reaches the **Smart Load OFF Batt** value.
11. The Sol-Ark triggers the AC Coupled solar PV array to produce power (powering the loads and charging the batteries) when the batteries' SoC level exceeds this programmed **Smart Load ON Batt** value.



CAUTION: When PHI battery quantities change, the capacity & charge/discharge current settings must be reassessed. Failure to do so will void the Warranty.

Grid Setup

The Sol-Ark's **Grid Setup** menu includes many advanced features (refer to Section 5 of this Guide). Regardless of the features used, the PHI battery bank should never discharge more than its maximum continuous discharge rate. Furthermore, to maintain the PHI batteries' Warranty at a 10,000-cycle level, also do not discharge the battery bank to a State of Charge (SoC) level less than 20%. These details are controlled in the **Grid Setup** menu's **Limiters** tab.

Figure 4 – Limiter Tab in Grid Setup menu

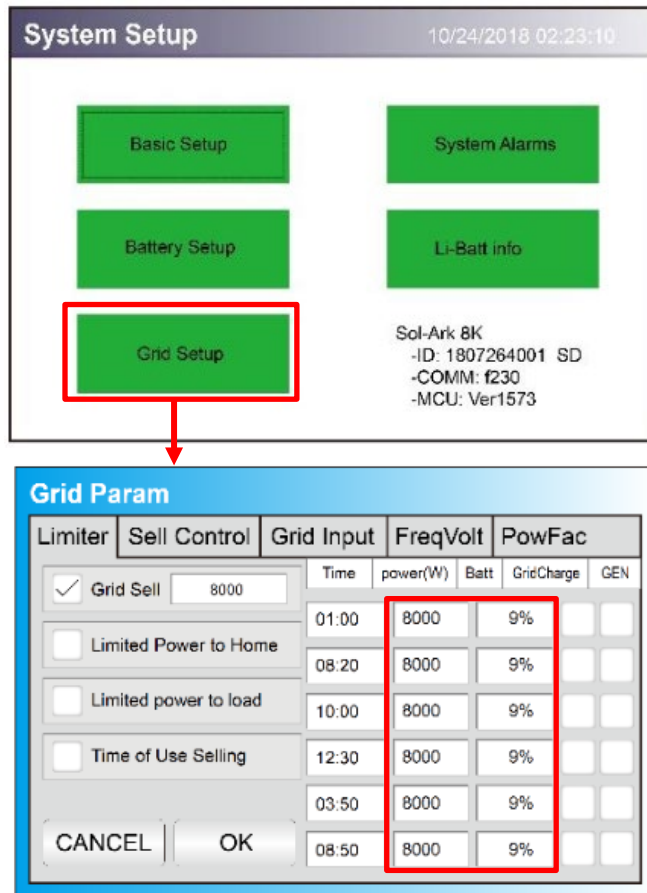

The **power (W)** column in Figure 4 above dictates the maximum amount of power pulled from the batteries and should be set to the PHI battery bank’s maximum discharge rate in AC Watts. To calculate the connected PHI battery bank’s maximum discharge Watts (AC):

1. Multiply the number of batteries in the bank by the maximum discharge rate (ADC) per battery
 - a. PHI 3.8-51.2V_{nom} battery max. discharge rate = 37.5 ADC per battery
 - b. PHI 2.9-51.2V_{nom} battery max. discharge rate = 28.5 ADC per battery
2. Convert the battery bank’s DC discharge current to DC discharge watts.
3. Apply the discharge efficiency.

The following Tables 2 and 3 describe the continuous power output limitations of the PHI 51.2V_{nom}-model batteries. Populate the **power (W)** column according to these tables.

Populate the **Batt** column to the right of the **power (W)** column according to the degree to which you wish to discharge the battery bank. Again, to maintain the PHI batteries at the 10,000-cycle Warranty level, do not populate the **Batt** column with any value less than 20%.

Table 2 – Conversion from DC to AC Discharge Limit for 1 to 6 PHI 3.8 kWh-51.2V_{nom} Batteries

A	B	C	D	E
# of Parallel Batteries	DC Current Limit	ADC X VDC (48)	WDC X Discharge Efficiency (95%)	MAX Battery Output (WAC)
1	37.5 Amps DC	1,800 Watts DC	1,710 Watts AC	1,710 Watts AC
2	75 ADC	3,600 WDC	3,420 WAC	3,420 WAC
3	112.5 ADC	5,400 WDC	5,130 WAC	5,130 WAC
4	150 ADC	7,200 WDC	6,840 WAC	6,840 WAC
5	187.5 ADC	9,000 WDC	8,550 WAC	8,550 WAC*
6	225 ADC	10,800 WDC	10,260 WAC	10,260 WAC*

*Limited by the Sol-Ark to 8,000 WAC in Off-Grid mode and 9,000 WAC in Grid-Tie mode.

Note: Sol-Ark’s Manual shows these **power (W)** parameters programmed to $1,000 \text{ Watts} \times \text{PHI Battery Quantity}$. While there is no harm in using this approximation, the greater values outlined in the tables above may be used.

5. USE CASES & APPLICATION NOTES

Sol-Ark equipment includes many advanced programming features and a variety of modes (more than one mode can be used simultaneously). This section of the Guide will outline the system programming and setup basics for common use cases. However, refer also to the Sol-Ark Manual for all installation requirements relevant to the application at hand.

Table 4 – Sol-Ark Grid Settings

System Setup > Grid Setup	80% DoD (10k cycle warranty)	90% DoD (5k cycle warranty)	100% DoD (3.5k cycle warranty)
> Limiter Tab			
Grid Sell	check this box when exporting solar PV power to the grid (Net Energy Metering agreement required)		
	set the numerical value to the maximum number of exporting Watts		
Limited Power to Home	check this box when powering both the critical loads sub-panel and the main house breaker panel using solar and/or battery, without exporting energy to the grid (limiter sensors required)		
Limited power to load	check this box when powering the critical loads sub-panel using solar and/or battery		
Time of Use Selling	check this box when discharging the batteries during set times (either the Grid Sell or Limited Power to Home box must also be checked)		

Time	sets the time at which the batteries discharge to power both the critical loads sub-panel and the main house breaker panel (limiter sensors required)		
power (W)	sets the maximum amount of power discharged from the batteries during the set time		
	do not exceed the Wattage values listed in Tables 2 or 3 above		
Batt	the percentage SoC to which the batteries discharge during the set time		
	20%	10%	0%
Grid Charge	check this box to allow for grid-to-battery charging during the set time		
GEN	check this box to allow for gen-to-battery charging during the set time		
> Sell Control Tab	80% DoD	90% DoD	100% DoD
General Standard	check this box when a generator is wired to the Grid Input or to use the Protect Param settings listed in the Grid Input tab		
UL 1741 & IEEE 1547	check this box for grid sell compliant functionality (default)		
CA Rule 21	check this box for compliance with CA Rule 21		
UL 1741SA	check this box for compliance with HECO Rule 14H and/or PREPA		
GEN connect to Grid input	check this box when a generator is wired to the Grid Input		
> Grid Input Tab			
Grid Frequency	select 50 Hz or 60 Hz		
Grid Type	select 120/240V split phase (North America), or contact SimpliPhi to special-order 220V single phase or 120/208V 3 phase		
Protect Param	leave as default values when UL 1741 & IEEE 1547 are enabled frequency values may change when a generator is wired to the Grid Input		
> FreqVolt tab	refer to the Sol-Ark Manual for Puerto Rico or Kauai-specific settings		

AC Coupled

In an AC Coupled system setup, the grid-tie inverter(s) output – string or micro-inverters – is wired to the Sol-Ark’s Generator Input (40A double-pole breaker) and the **For Micro inverter input** box in the **Smart Load** tab of the **Battery Setup** menu must be checked:

Figure 5 – Smart Load Tab in Batt Setup menu

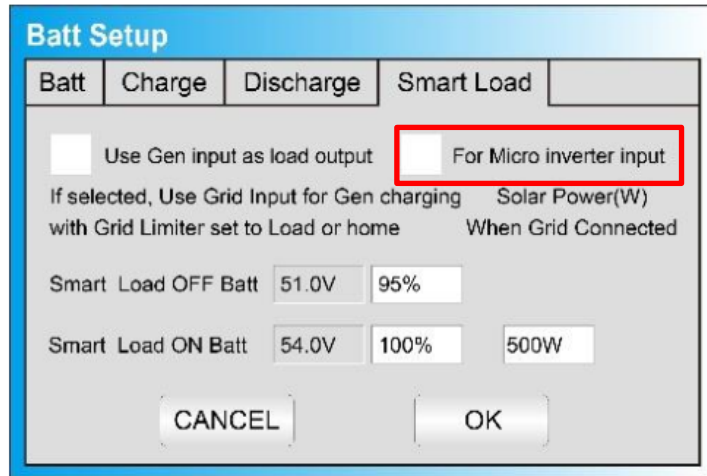

The Sol-Ark-8K is limited to a maximum of 7 kW of AC Coupled solar PV, and the Sol-Ark-12K is limited to 7.6 kW of AC Coupled solar. AC Coupled systems can operate in Grid Sell / Grid-Tied with Battery Backup, Limited to Home, Limited to Load, or Time of Use Selling modes.

Grid Sell / Grid-Tied with Battery Backup

A net energy metering agreement with the utility company is required in order to sell energy from the solar PV array to the grid. In this mode, the Sol-Ark prioritizes powering all loads (on both the critical loads sub-panel and the main house breaker panel) from solar PV first (if available), then (2) grid, (3) generator, and (4) batteries. In the event of a grid failure, the batteries will power the critical loads sub-panel only. Take care to size the battery bank accordingly; in a grid failure scenario, the Sol-Ark does not limit the batteries' maximum current output. The maximum power draw (kW) on the critical loads sub-panel should not exceed the maximum continuous discharge rate of the PHI battery bank. Refer to the Discharge Calculation in Section 3 of this Guide:

$$B_{\#Inv} \geq \frac{Inv_{kW} \div Inv_{eff}}{Bat_{kW}}$$

Discharge Example:

- Circuits on the critical loads sub-panel amount to a maximum potential power draw of 30 Amps at 240 VAC, or 7.2 kW_{AC}
- Sol-Ark-8K inverter DC-to-AC efficiency is 95.5%
- PHI 3.8 kWh-51.2V_{nom} battery has a maximum continuous discharge rate of 1.92 kW_{DC}

$$B_{\#Inv} \geq \frac{7.2_{kW} \div 0.955_{eff}}{1.92_{kW}} = 3.9$$

A properly sized PHI battery bank based on the maximum draw of the critical loads sub-panel has a minimum of **4 batteries**, even in this Grid-Tied with Battery Backup application. Note also that during a grid failure, the critical loads' maximum energy draw (kWh) is also limited by the battery bank's capacity.

Limited to Home

Checking the **Limited power to Home** box in the **Limiter** tab of the Sol-Ark's **Grid Setup / Grid Param** menu allows for all loads* (on both the critical loads sub-panel and the main house breaker panel) to be powered using the connected solar PV and/or batteries. The Sol-Ark prioritizes powering these loads from solar PV first (if available), then (2) grid, (3) generator, and (4) batteries. To prioritize the batteries' use over the grid or generator during specific set times, also use the **Time of Use Selling** mode.

*While the **Limited to Home** mode *allows* for all loads to be powered using solar PV and/or batteries, the Sol-Ark prioritizes powering loads on the critical loads sub-panel first, and loads on the main house breaker panel are offset by solar (and/or batteries, during Time of Use Selling mode times) *as much as possible*. If the loads' draw exceeds the available power from the solar PV array and (with **Time of Use Selling** mode also in play) the batteries have also discharged to their minimum programmed SoC percentage level, the Sol-Ark will then resort to powering loads using grid power.



CAUTION: In Limited to Home mode, limiter sensors are required to ensure that the home's main breaker panel circuits are powered without exporting energy to the grid.

Limited to Load

Checking the **Limited power to load** box in the **Limiter** tab of the Sol-Ark's **Grid Setup / Grid Param** menu discharges the battery to power the critical loads sub-panel's loads. The **Limited to Load** mode does not allow for any solar or battery energy to power the main house breaker panel and it does not allow for any solar or battery energy to be exported to the grid.

Figure 6 – Limiter Tab in Grid Setup menu

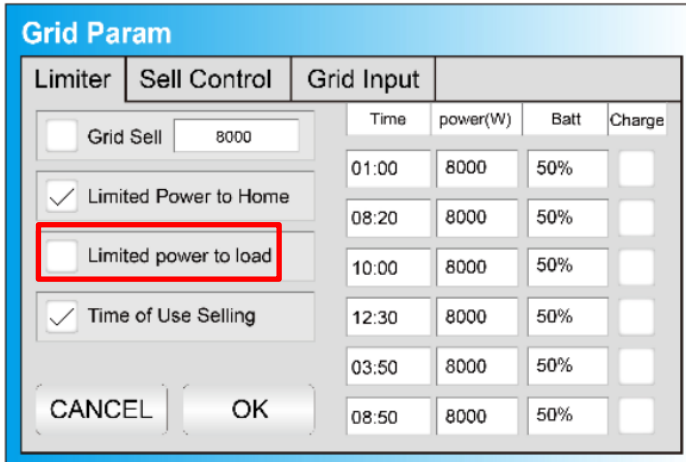

Grid Param		Time	power(W)	Batt	Charge
<input type="checkbox"/>	Grid Sell		8000		
<input checked="" type="checkbox"/>	Limited Power to Home	01:00	8000	50%	<input type="checkbox"/>
<input type="checkbox"/>	Limited power to load	08:20	8000	50%	<input type="checkbox"/>
<input checked="" type="checkbox"/>	Time of Use Selling	10:00	8000	50%	<input type="checkbox"/>
		12:30	8000	50%	<input type="checkbox"/>
		03:50	8000	50%	<input type="checkbox"/>
		08:50	8000	50%	<input type="checkbox"/>

CANCEL OK

Time of Use Selling / Energy Arbitrage

Discharge batteries to power circuits during specific set times. Program these times to coincide with the utility company's peak pricing times to avoid high energy charges from the utility.

Homeowners who have a net energy metering agreement with the utility company can use both **Grid Sell** and **Time of Use Selling** modes to sell solar PV and battery energy (until the minimum programmed SoC percentage level) back to the grid during peak sun-hour times and then discharge the batteries during programmed times, usually in the afternoon and evening. Depending on whether **Limited power to load** or **Limited Power to Home** is enabled, the batteries will power either the critical loads sub-panel only (**Limited to Load**) or the critical loads sub-panel and the main house breaker panel (**Limited to Home**) during the **Time of Use Selling** time period. Make sure to size the battery accordingly. (Refer to the Discharge Example in the **Grid Sell / Grid-Tied with Battery Backup** section of this Guide for battery bank sizing when batteries power the critical loads sub-panel only. Refer to the Discharge Example in Section 3 of this Guide for battery bank sizing when the batteries power both the critical loads sub-panel and the main house breaker panel.)

Homeowners who do not have a net energy metering agreement use both **Limited Power to Home** and **Time of Use Selling** modes to prioritize powering all loads (circuits both on the critical loads sub-panel and the main house breaker panel) from the solar and/or batteries during programmed times. Refer to the Discharge Example in Section 3 of this Guide for battery bank sizing when the batteries power both the critical loads sub-panel and the main house breaker panel.



NOTE: Either the Grid Sell or the Limited Power to Home mode (check the appropriate box in the Grid Setup / Grid Param menu) must be used in conjunction with Time of Use Selling.

During **Time of Use Selling** times, loads are powered from solar first (if available), batteries second, and the grid third (if batteries have discharged to their programmed minimum SoC percentage level).

Make sure the **GridCharge** box is **unchecked** during peak pricing times so that the batteries do not charge when energy from the utility company is most expensive (see Figure 7).

Figure 7 - Limiter Tab in Grid Setup menu

Grid Param							
Limiter	Sell Control	Grid Input	FreqVolt	PowFac	GridCharge	GEN	
<input checked="" type="checkbox"/>	Grid Sell	8000	Time	power(W)	Batt	GridCharge	GEN
			01:00	8000	9%	<input type="checkbox"/>	<input type="checkbox"/>
<input type="checkbox"/>	Limited Power to Home		08:20	8000	9%	<input type="checkbox"/>	<input type="checkbox"/>
<input type="checkbox"/>	Limited power to load		10:00	8000	9%	<input type="checkbox"/>	<input type="checkbox"/>
<input type="checkbox"/>	Time of Use Selling		12:30	8000	9%	<input type="checkbox"/>	<input type="checkbox"/>
			03:50	8000	9%	<input type="checkbox"/>	<input type="checkbox"/>
			08:50	8000	9%	<input type="checkbox"/>	<input type="checkbox"/>

CANCEL | OK

Off-Grid

The Sol-Ark automatically operates in **Off-Grid** mode when it does not detect a grid connection.

In an Off-Grid system setup, all the home's loads are connected to the Sol-Ark's Load Output (50A double-pole breaker).

Do not use the Sol-Ark's **Grid Sell** and **Limited to Home** modes in an off-grid system setup.

Check the **Limited power to load** box in the **Limiter** tab of the Sol-Ark's **Grid Setup / Grid Param** menu to allow for the batteries' power to discharge to the connected loads.

Generators

The Sol-Ark's built-in Auto Generator Start functions as a 2-wire automatic switch.

The Sol-Ark's Grid Input breaker can be used as the generator's input breaker. In this scenario, check the **General Standard** box and the **GEN connect to Grid input** box in the **Grid Param** menu's **Sell Control** tab:

Figure 8 – Sell Control Tab in Grid Setup menu

The screenshot shows the 'Grid Param' menu with the 'Sell Control' tab selected. The 'General Standard' checkbox is checked and highlighted with a red box. The 'GEN connect to Grid input' checkbox is also checked and highlighted with a red box. Other options include 'UL 1741 & IEEE1547', 'CA Rule 21', and 'UL 1741SA'. The 'Grid Reconnect Time' is set to '60s' and the 'Power Factor' is '1.000'. There are 'CANCEL' and 'OK' buttons at the bottom.

Due to the fact that many generators' output frequency is usually less precise than the grid's, the frequency parameters in the **Grid Param** menu's **Grid Input** tab may also need adjustment to accommodate a wider frequency range:

Figure 9 – Grid Input Tab in Grid Setup menu

The screenshot shows the 'Grid Param' menu with the 'Grid Input' tab selected. The 'Grid Frequency' is set to '50Hz'. The 'Grid Type' is set to '220V Single Phase'. The 'Grid Hz High' is set to '60.5Hz' and the 'Grid Hz Low' is set to '45.0Hz', both highlighted with a red box. Other parameters include 'Grid Vol High' (264.0V) and 'Grid Vol Low' (211.0V). There are 'CANCEL' and 'OK' buttons at the bottom.

Homeowners who wish to include a grid connection, generator, and Smart Load functionality can install a transfer switch allowing for either grid or generator to connect to the Sol-Ark's Grid Input. This frees up the Sol-Ark's Generator Input to be used as an output for Smart Loads (see the following Smart Loads section for more details).

In an AC Coupled system setup that includes a generator, using a transfer switch for a grid-or-generator connection to the Sol-Ark's Grid Input also frees up the Sol-Ark Generator Input for connection to the AC Coupled solar PV array.

If the system includes both a generator and a grid connection, limiter sensors are required. While smaller generators (less than 10 kW) can be wired to the Sol-Ark's Generator Input, Sol-Ark recommends wiring larger generators to a whole home transfer switch instead of using the inverter's Generator Input.

Smart Load

The Smart Load feature allows the homeowner to run higher power non-essential appliances (hot water, dehumidifier, heat pump, irrigation pump, etc.) on solar when excess solar power is available. This setup involves connecting these higher power non-essential loads to the Sol-Ark's Generator Input. To partially protect the batteries against over-discharge, set the **Smart Load Off Batt** and **Smart Load ON Batt** parameters to the batteries' acceptable SoC percentage range while in this mode. However, note that no programmable parameter exists to regulate the batteries' over-discharge from a current perspective.

For example, an off-grid system with home loads totaling a maximum instantaneous power draw of 8 kW might include 5 PHI 3.8 batteries, with a maximum combined continuous power output of 9.6 kW_{DC} / 9.168 kW_{AC}. With both the **Smart Load** and **Limited to Load** modes enabled and the **Smart Load ON Batt** parameter set to 100% SoC, the Sol-Ark will begin powering the Smart Loads (in addition to all the home loads) when the batteries are at 100% SoC. If the Smart Load power draw exceeds 9.168 kW_{AC}, (38.2 Amps at 240VAC), the batteries will then be operating beyond their maximum continuous power output capabilities. While the batteries have a maximum surge discharge capability of 60 Amps DC per battery (15.36 kW_{DC} / 14.669 kW_{AC} for the 5-battery bank), the batteries cannot surge at this power level for more than 10 minutes. A Smart Load drawing more than 9.168 kW_{AC} for more than 10 minutes will very likely result in the batteries' SoC level reaching the **Smart Load OFF Batt** parameter, if it is set to 95%. However, feel free to reach out SimpliPhi Power Technical Support (TechSupport@SimpliPhiPower.com) if the Smart Load feature will be used and battery bank sizing clarification according to Smart Load-specific loads needs to be clarified.

Note that in a grid-connected system that utilizes the **Smart Load** feature, the Wattage value to the right of the **Smart Load ON Batt** parameter in the **Smart Load** menu tab (see Figure 5) represents the minimum power required of the solar PV array before the Smart Loads are powered. Therefore, that Solar PV Wattage value can be added to the battery bank's maximum output power rating when comparing maximum available solar and battery power available, against the Smart Load power draw: **Smart Load Draw (kW) ≤ Solar PV (kW) + Battery Bank MAX Output Power (kW)**.



CAUTION: Smart Loads' maximum power draw cannot exceed the Generator Input breaker's 40 Amp / 240VAC rating.

6. SPECIFICATIONS & WARRANTY

For your reference:

- See PHI 3.8 kWh Specifications Sheet.
- See PHI 2.9 kWh Specifications Sheet.
- See [PHI Battery 10 Year Limited Warranty](#).
Failure to adhere to installation protocol will void the Warranty.

7. SIMPLIPHI TECHNICAL SUPPORT

For technical support related to your PHI Battery (or other SimpliPhi Power products), please contact us directly at:

805.640.6700

techsupport@simpliphipower.com