



FLEXware™ 500 **User's Guide**

Includes Mounting, Installation, and
Product Registration



19009 62nd Avenue NE
Arlington, WA USA
(+1) 360-435-6030

European Sales Office
Barcelona, España
(+34) 600-843-845

www.outbackpower.com

900-0002-01-00



OutBack Power Systems FLEXware is a system of modular aluminum mounting hardware and installation components designed for convenient system installation and integration.

About OutBack Power Systems

OutBack Power Systems is a leader in advanced energy conversion technology. Our products include true sine wave inverter/chargers, a maximum power point charge controller, system communication components, as well as breaker panels, breakers, accessories, and assembled systems.

Notice of Copyright

FLEXware 500 Manual Copyright © 2006 All rights reserved.

Disclaimer

UNLESS SPECIFICALLY AGREED TO IN WRITING, OUTBACK POWER SYSTEMS:

(a) MAKES NO WARRANTY AS TO THE ACCURACY, SUFFICIENCY OR SUITABILITY OF ANY TECHNICAL OR OTHER INFORMATION PROVIDED IN ITS MANUALS OR OTHER DOCUMENTATION.

(b) ASSUMES NO RESPONSIBILITY OR LIABILITY FOR LOSS OR DAMAGE, WHETHER DIRECT, INDIRECT, CONSEQUENTIAL OR INCIDENTAL, WHICH MIGHT ARISE OUT OF THE USE OF SUCH INFORMATION. THE USE OF ANY SUCH INFORMATION WILL BE ENTIRELY AT THE USER'S RISK.

Revision

September 2007

Contact Information

OutBack Power Systems
19009 62nd Ave. NE
Arlington, WA 98223
Phone (360) 435-6030
Fax (360) 435-6019
www.outbackpower.com

Product Registration

Please take a moment to register and provide us with some important information. Send to:
OutBack Power Systems, 19009 62nd Avenue NE, Arlington, WA 98223 USA.

Name: _____

Address: _____

City, State, Zip Code: _____

Country: _____

Telephone Number: _____

E-mail: _____

Sold by: _____

Installer: _____

Purchase Date: _____ Model Number: _____

Serial Number: _____

Check all that apply:

Off-Grid Installation Grid-Tie Installation Residential Installation Commercial Installation

Requirements and Warnings

The OutBack FLEXware 500 enclosures (FW500-AC and FW500-DC) are listed by ETL as indoor enclosures to UL standard UL 508A Industrial Control Panels.

This enclosure is intended for battery circuits configured for 12 to 48 volts nominal.

Grounding Instructions – Each enclosure should be connected to a grounded, permanent wiring system. For most installations, the negative battery conductor should be bonded to the grounding system at one (and only one) point in the DC system. All installations must comply with all national and local codes and ordinances. System grounding as required by the National Electric Code, ANSI /NFPA 70-1996, is the responsibility of the system installer.

The equipment ground on FLEXware 500 is marked with this symbol: 

FLEXware is designed for indoor mounting only with appropriate fasteners and a secure mounting surface that can handle the full weight of an assembled system.

Welcome to OutBack Power Systems' FLEXware

FLEXware is a convenient all-aluminum power system offering simpler, code-compliant installation of OutBack power electronics components. Three versions of FLEXware are available:

- FLEXware 250 for single FX Series Inverter/Charger installations along with the desired AC and DC disconnects
- FLEXware 500, which supports up to two FXs and two MX Charge Controllers, accommodating both split-phase and/or higher power output as needed
- FLEXware 1000 accommodates up to four FXs and four MX Charge Controllers

Please Note: Both the FLEXware 500 and the FLEXware 1000 power systems provide locations for FW-X240 Auto-Transformers, multiple DC shunts and other essential components required in higher kW systems.

Getting to Know FLEXware 500

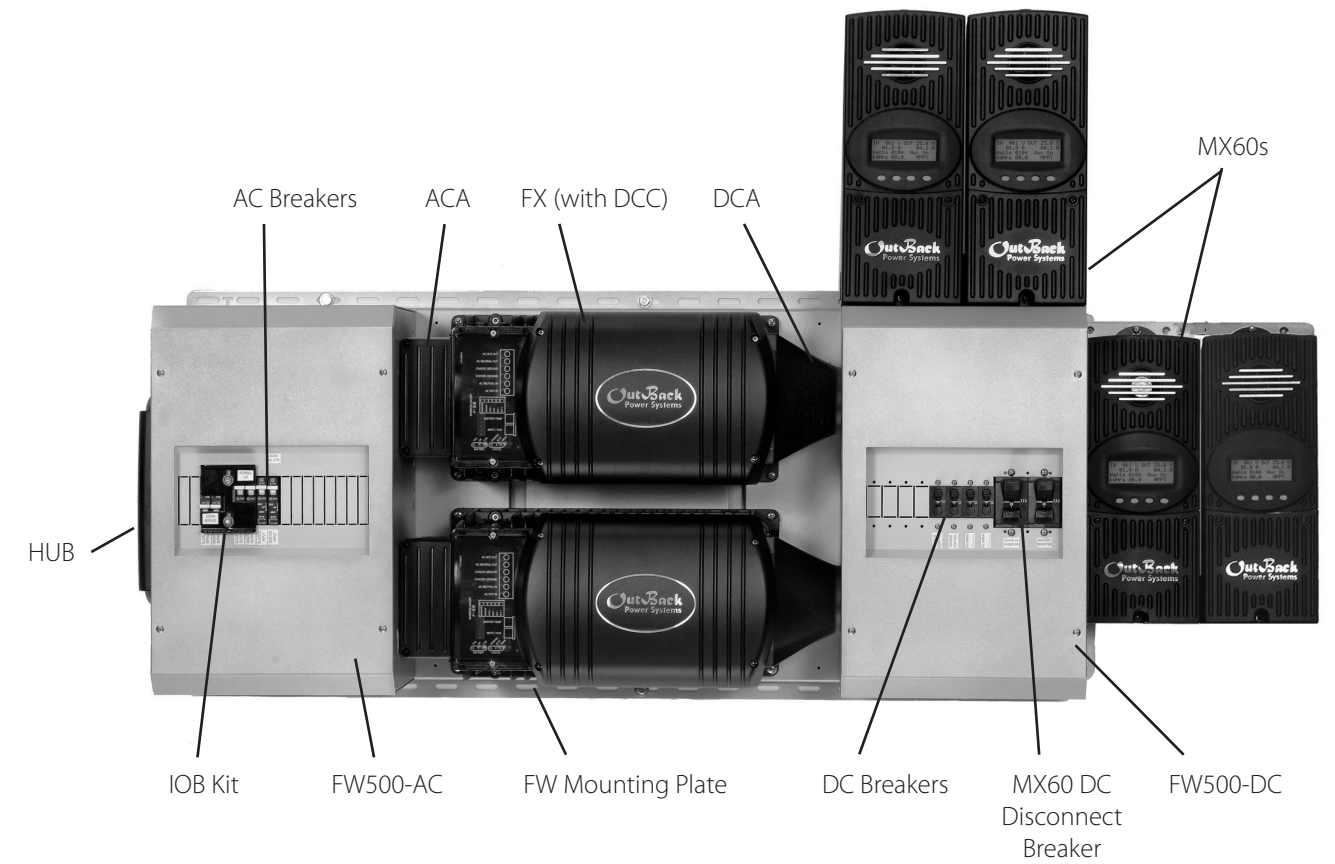
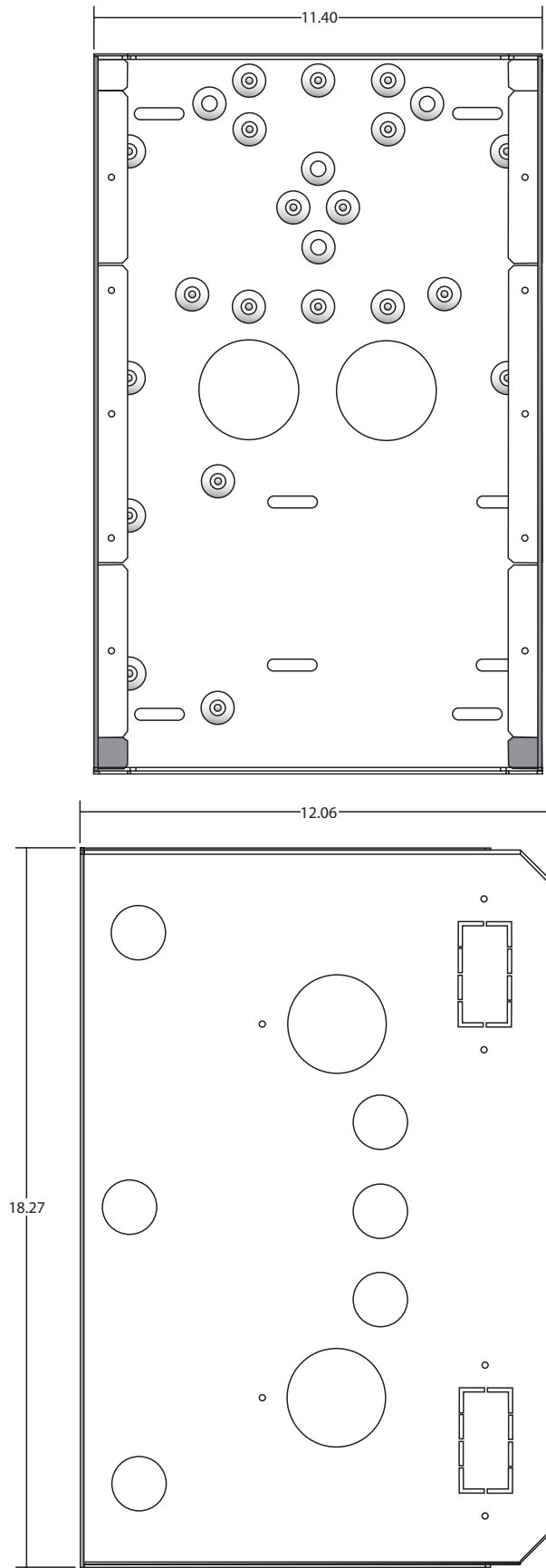

Figure 1: Complete FLEXware 500 System installed (vertical installation is acceptable when mounting space is limited)

Note: Although FLEXware 500 supports two MX Charge Controllers, both locations—top and side—are shown in Figure 1.

Knockouts and Dimensions



Front View

Side View

Figure 2

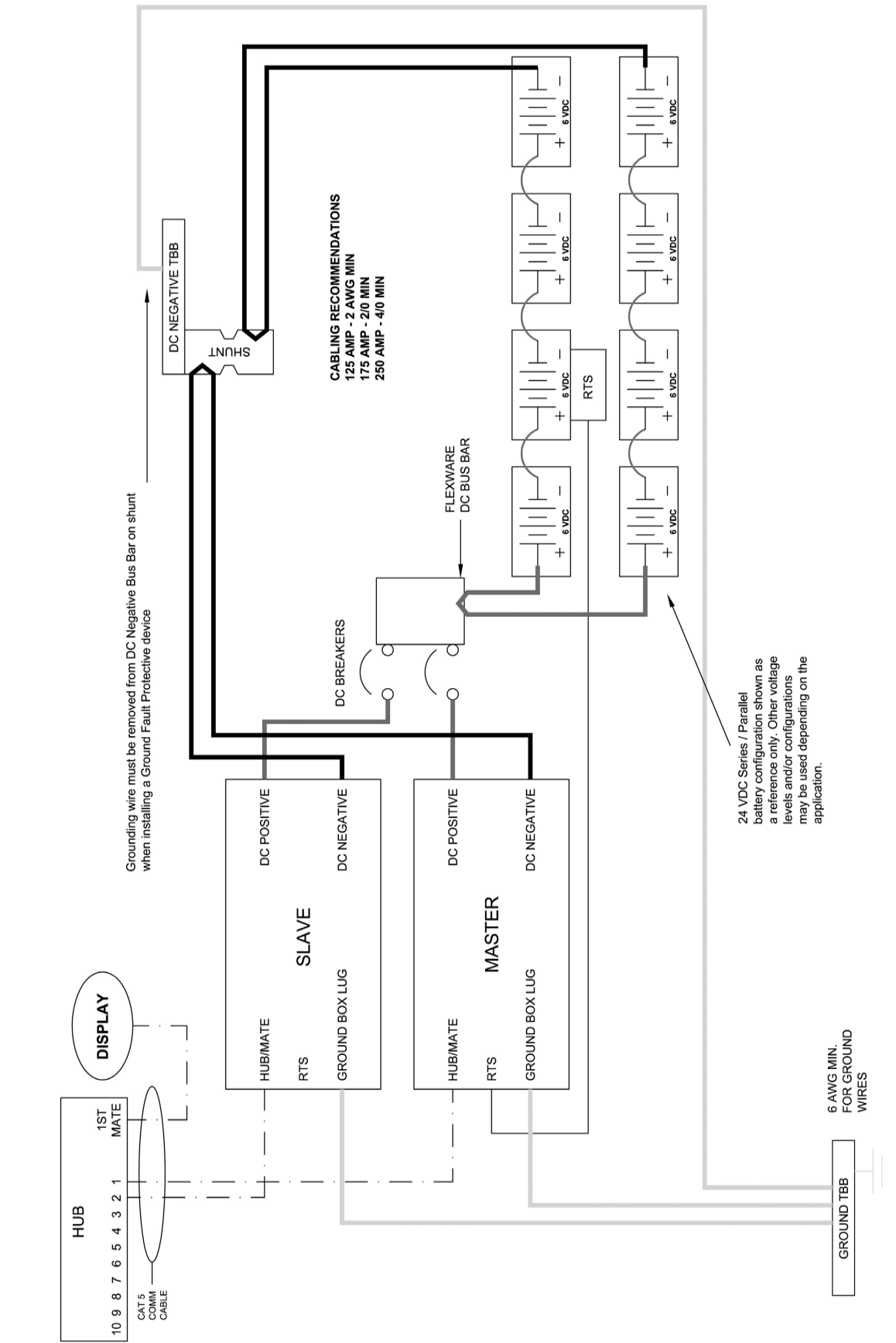

Figure 15: Wiring Diagram

Installing an OutBack HUB

An OutBack HUB allows the FX Series Inverter/Chargers, MX60 Charge Controllers, and MATE to communicate with each other. It attaches to the outside of the FW500-AC (hardware included with the HUB).

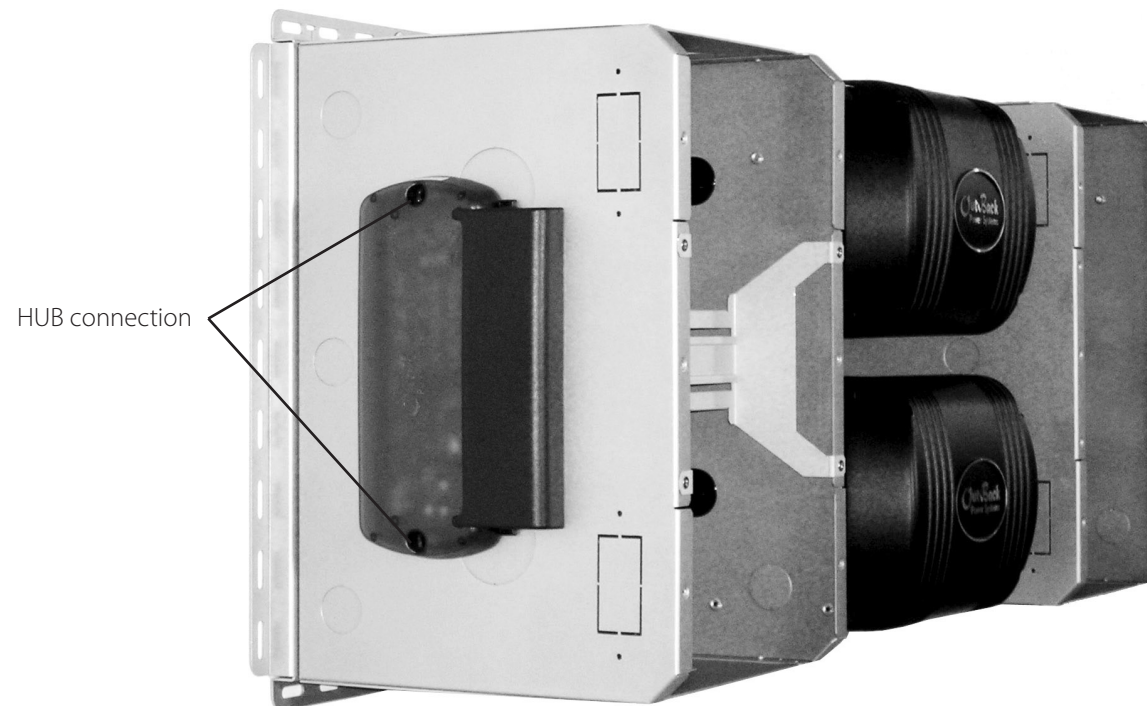

Figure 14: OutBack HUB

A complete FLEXware 500 System consists of the following in addition to the FW500-AC and FW500-DC:

- FLEXware Mounting Plate (FW-MP)
- two FX Series Inverter/Chargers
- AC Conduit Adapter (ACA) and a DC Conduit Adapter (DCA), which connect each FX to the FW500-AC and FW500-DC
- MX Charge Controller(s) (normally part of this system) and mounting brackets
- AC and DC breakers including a specific AC Input/Output/Bypass Breaker (IOB) Kit per installation
- bus bars and DC current shunts as required per specific installation
- DC and AC ground fault protection

Some systems will work optimally with an FW-X240 Auto-Transformer installed.

Note: Be sure you have all the parts required for your intended system installation. As every installation is different, consult with your dealer or installer for further information.

FLEXware 500 Parts List

FLEXware 500 consists of the FW500-AC and FW500-DC. Each is an aluminum chassis for mounting AC and DC breakers, respectively, along with the components listed below:

FW500-AC components:

- aluminum enclosure
- DIN rail bracket
- Breaker and Bypass Mounting Bracket
- TBB-GROUND
- flex nylon conduit and fittings (conduit runs between the FW500-AC and FW500-DC as needed)

FW500-DC components:

- aluminum enclosure
- 500 amp shunt with TBB attached
- TBB-GROUND
- FW breaker bus
- DC Breaker Mounting Bracket
- FW500-DC Hardware Kit
- DC positive bus bar
- jumper wire from DC negative to ground

Installation Tips

- Never use less than the minimum recommended number and type of fasteners when installing the FLEXware Mounting Plates.
- Each FX weighs in excess of 50 lbs and is often more easily installed by two people rather than one.
- Be sure the DC enclosure is secured to the FLEXware Mounting Plate before attaching the MX Charge Controller to it.
- Installation of each enclosure and breakers is normally easier by removing the breaker brackets first. Do not remove any breaker knockouts from these brackets without referring to the chosen AC IOB kits and DC breaker selections first.
- It is also easier if all conduit knockouts are removed before mounting the enclosures.

Mounting and Installation

FLEXware 500 is designed for mounting on the FLEXware Mounting Plate (FW-MP). Although the components can be secured to other surfaces, the FW-MP is an engineered platform designed for the FLEXware 500 installation. This manual illustrates such an installation. **OutBack does not endorse other installation methods and therefore cannot recommend fasteners or other means of attachment due to the variety of installations possible in the field.**

Please see the FLEXware Mounting Plate Instructions for further information.

In addition to installing the AC and DC chassis, a typical installation includes two FX Series Inverter/Chargers, an MX60 Charge Controller, a HUB Communications Manager, and AC and DC conduit adapters. The installation of these components is also displayed in these instructions.

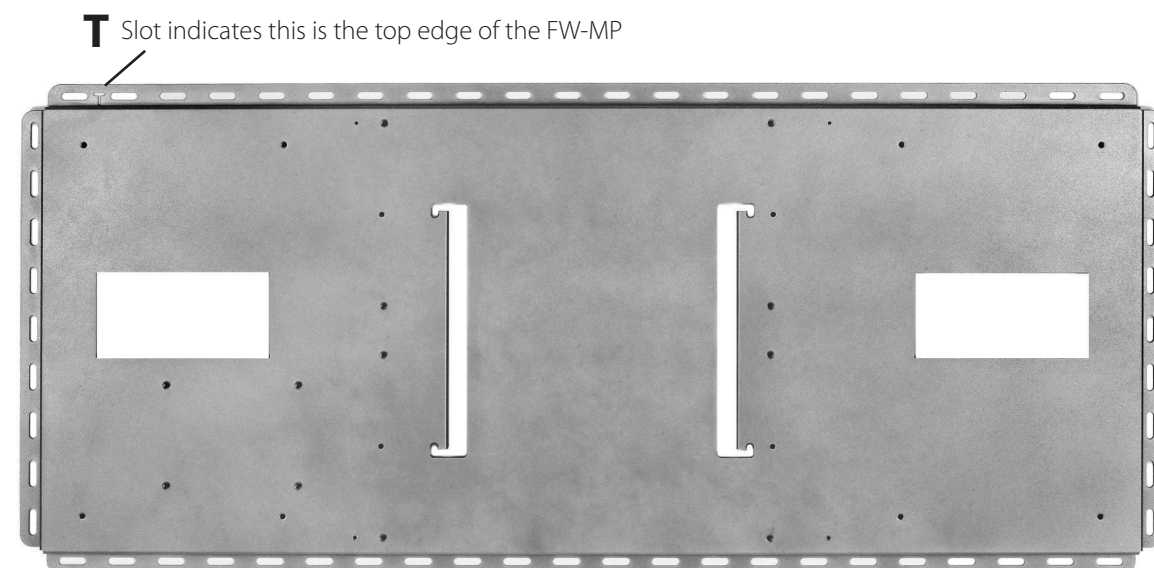

Figure 3: FLEXware Mounting Plate

MX Knockouts

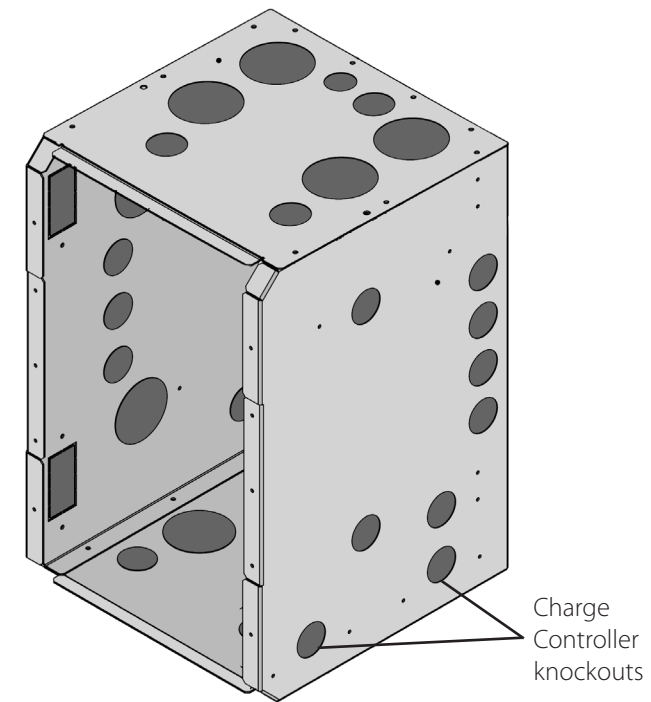

Figure 13:
MX Charge Controller 1" knockouts



The MX Charge Controller attaches to the chassis using three #10 X 3/8" sheet metal screws included in the hardware kit. Two are inserted from inside the MX and the third through the hanger on the top of the MX.

MX60 Installation

A FLEXware 500 System will normally have up to two MX Charge Controllers installed on the FW500-DC. The chassis accommodates both side and top installation. Newer MXs have rear knockouts allowing them to be mounted directly to the side of the enclosure without the need for additional mounting brackets. Mounting brackets are available for top installation of all MX models and for side installation less recent models.

Bracket screw locations are shown below

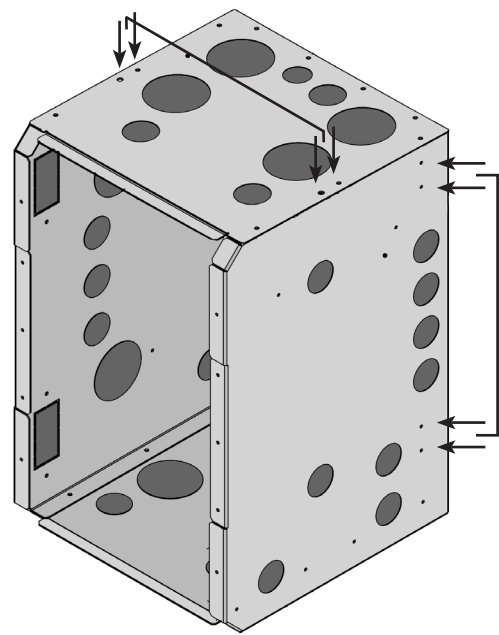

Screw locations for directly attaching an MX Charge Controller are shown below

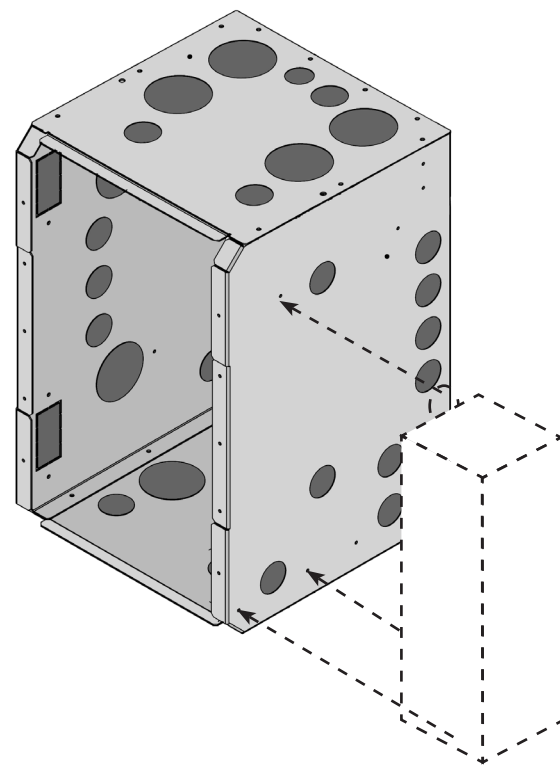

Figure 13:
MX Charge Controller mounting options

With the Mounting Plate *and the hanging screws* (for the FX Inverter/Chargers) inserted, install the FXs.

- Start with the top FX.
- Hang the FX on the hanging screws, but continue to hold onto it.
- Loosely install four M6 X 20 mm screws, included with the FW-MP, one in each corner; tighten them when all four are installed and the FX is aligned.
- Install the remaining FX in the same manner.

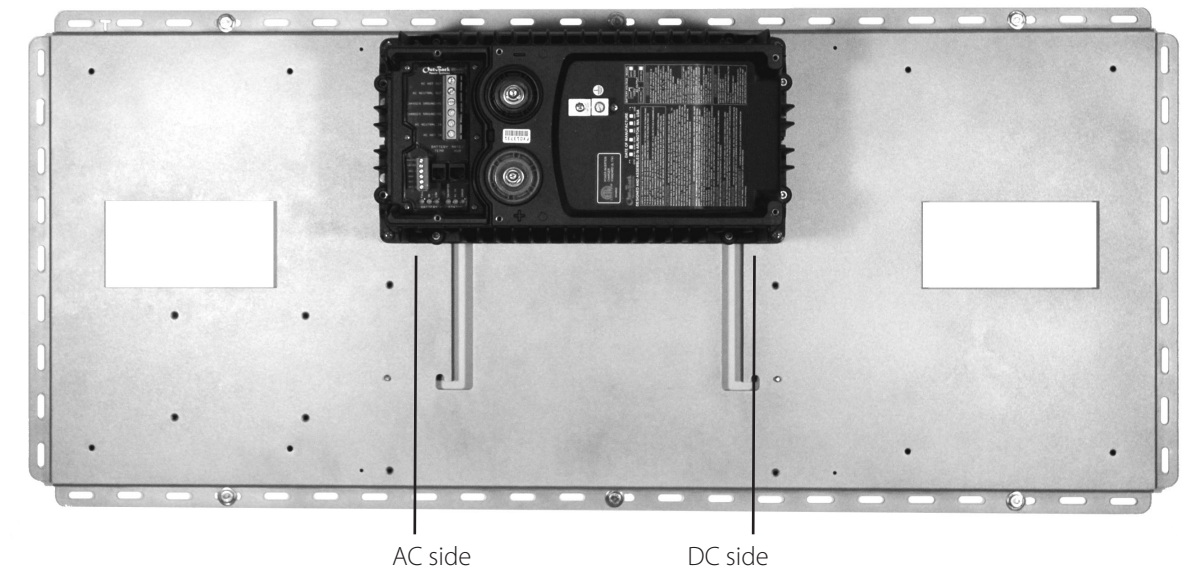

Figure 4: First FX installed

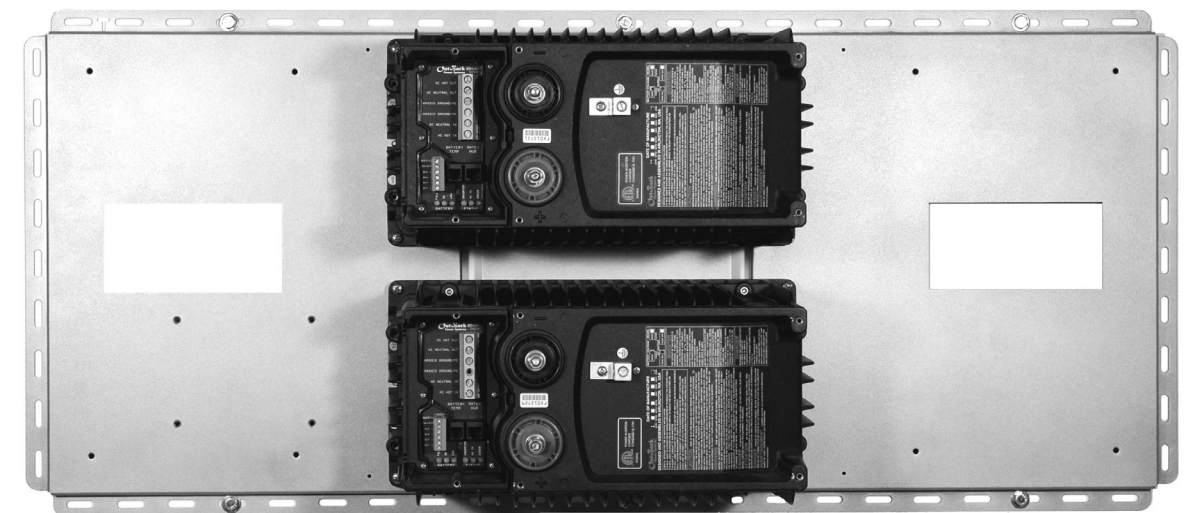

Figure 5: Both FXs installed

After the FXs are installed, mount the AC chassis and the DC chassis in either order.



Note: It is easier to remove the appropriate side knockouts from both the AC and DC chassis before installing either of them. If needed, the back knockouts must be removed before installation.

Figure 6: Removing chassis side knockouts

When installing the AC chassis and the DC chassis:

- Either chassis can be installed first, the order is not important.
- Only loosely install the four screws securing each chassis. The screws will be tightened later.

Each ACA fits against the AC chassis

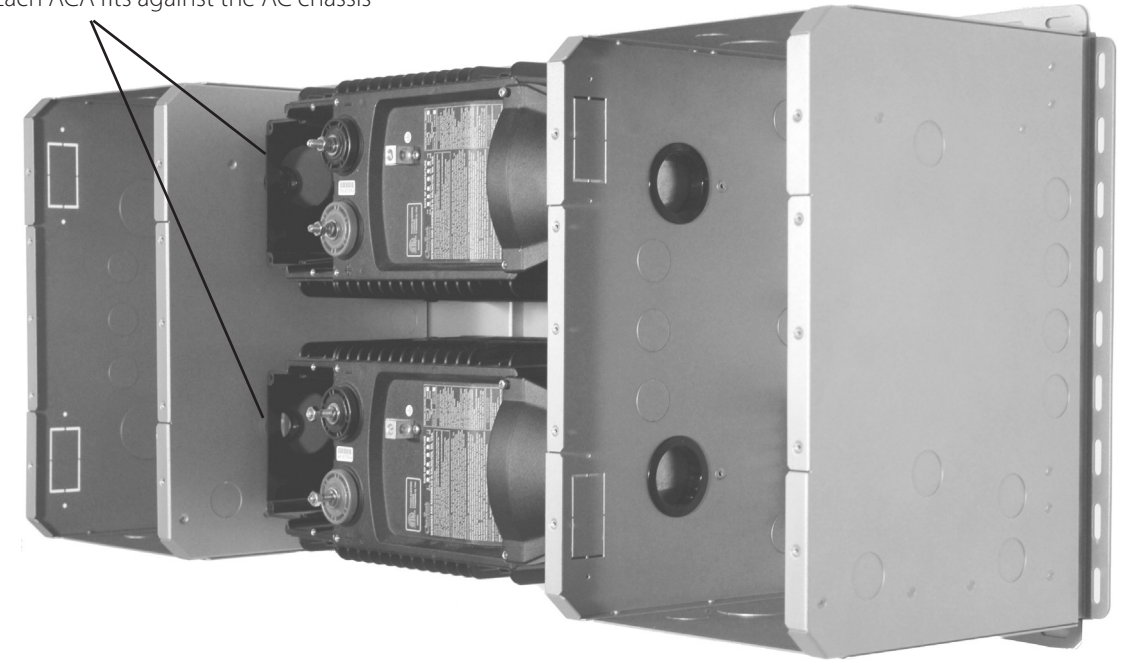

Figure 12: ACAs installed

With both the AC Chassis and DC Chassis installed, the breaker brackets, AC din rail(s), and optional AC and DC breakers can be installed. Please see the individual Input/Output/Bypass Breaker (IOB) kit for instructions.



Figure 11: DCA bushing

Note: The DCA will be held firmly in place when the DCC (FX cover) is secured at the end of the installation.

To install an ACA:

- Follow the separate ACA instructions for mounting to the FX.
- Line each ACA up with its conduit hole in the AC chassis.
- When aligned, move the AC chassis snug against the ACAs after the ACA installations.
- Press a 1" plastic bushing from inside the AC chassis out to the ACA through each previously removed knockout, sliding the AC chassis against the ACAs until snug.
- Install two M5 X 25mm screws (provided in ACA hardware kit) in each ACA and tighten securely.

Installation of the AC Chassis and DC Chassis

To install the chassis:

- Hold each chassis up to its respective mounting holes on the FW-MP.
- Place one M6 X 10mm machine screw (provided with the FW-MP) in each corner, tightening only enough to keep the chassis in place.

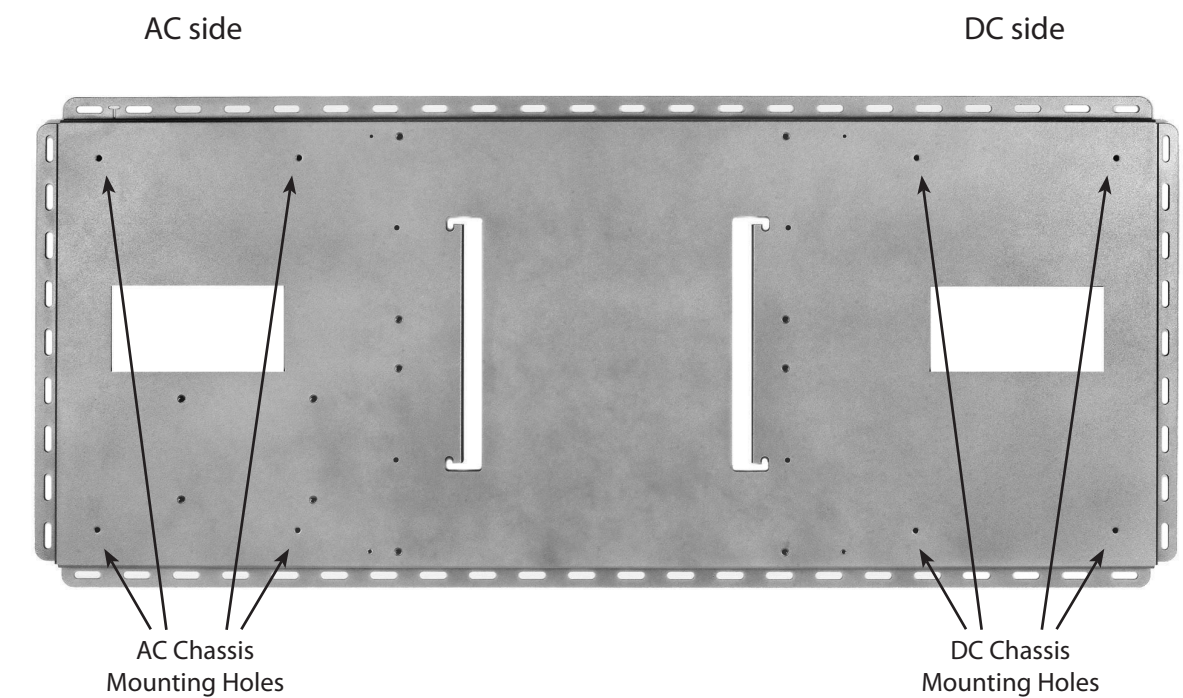

Figure 7: Chassis Mounting Holes

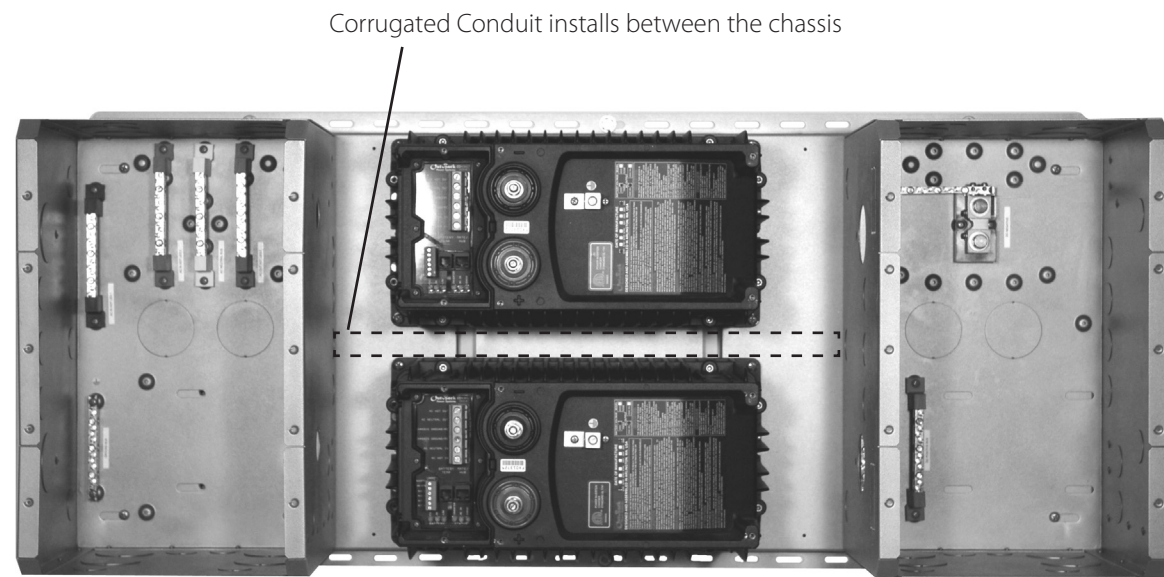

Figure 8: AC and DC chassis mounted

With each chassis loosely mounted, the AC Conduit Adapter (ACA) and DC Conduit Adapter (DCA) are installed on each FX.

- Remove the clear plastic AC cover and AC Conduit Plate from each FX.

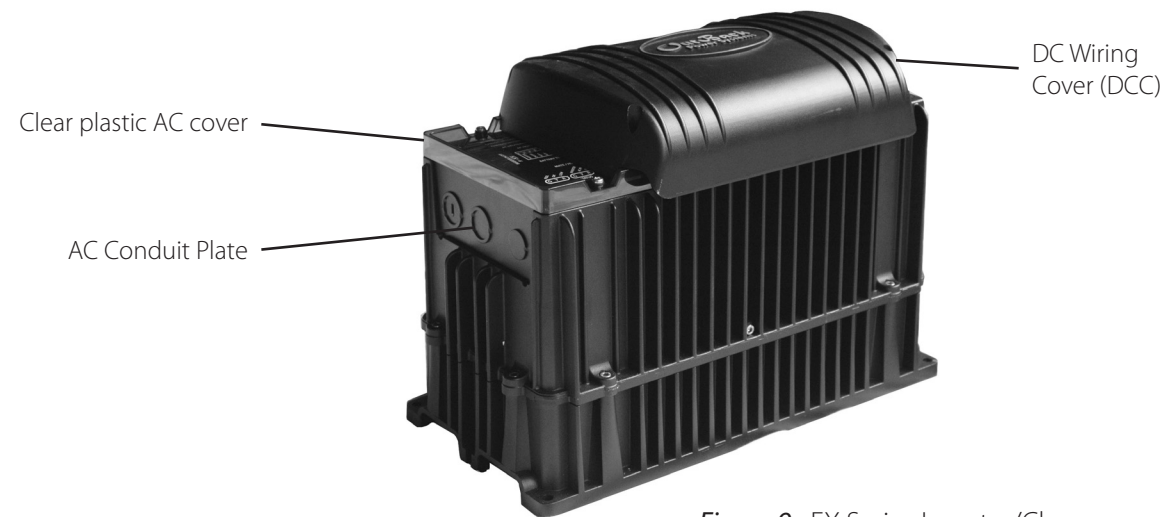

Figure 9: FX Series Inverter/Charger

- Line up either the ACA or DCA on its respective side of the FX, starting at the top.
- To attach a DCA, line up its two screw holes with the upper and lower right DCC screw holes.
- When lined up, loosely install the upper screw to hold the DCA in place.
- Slide the DC chassis over snug against the DCA (the screw slots in each chassis are oval-shaped to allow for movement) so the DCA lines up with the conduit adapter hole on the chassis.
- Install the plastic bushing from inside the chassis into the DCA (see Figure 11).
- After inserting the bushing into the top DCA, the remaining DCA will line up and the other bushing installed.
- With all the DCA's aligned with the DC chassis and the bushings installed, tighten the DC Chassis screws against the FW-MP.
- The single screws holding each DCA in place can be removed later when the DCC's are installed.

A single screw holds each DCA conduit adapter in place. Slide the DC chassis against each DCA and line it up with the plastic bushing.

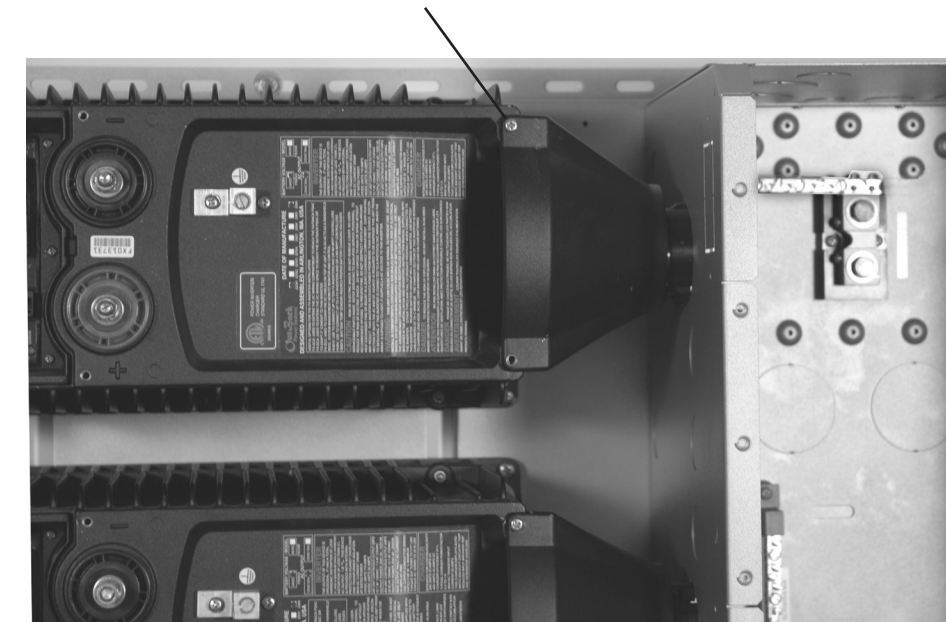

Figure 10: DCA in place