

Models:

- FLEXmax 80: 80 amps maximum continuous output current (up to 40°C without thermal derating)
- FLEXmax 60: 60 amps maximum continuous output current (up to 40°C without thermal derating)

Features:

- Maximum Power Point Tracking
- Supports 12, 24, 36, 48, and 60 Vdc battery voltages
- Backlit display screen (LCD) with 80 characters (4 lines, 20 characters per line)
- Last 128 days of operational data logging
- Voltage step-down capability allowing a higher PV array voltage configuration
- Manual and automatic equalize cycles

Screen Versions:

- English
- Spanish
- Australian (English with different default settings)

Maximum PV Input Wattage per Charge Controller

Battery Bank Voltage	Maximum PV Input Wattage for the FLEXmax 80	Maximum PV Input Wattage for the FLEXmax 60
12 Vdc	1000 W	750 W
24 Vdc	2000 W	1500 W
36 Vdc	3000 W	2250 W
48 Vdc	4000 W	3000 W
60 Vdc	5000 W	3750 W

FLEXmax Charge Controller

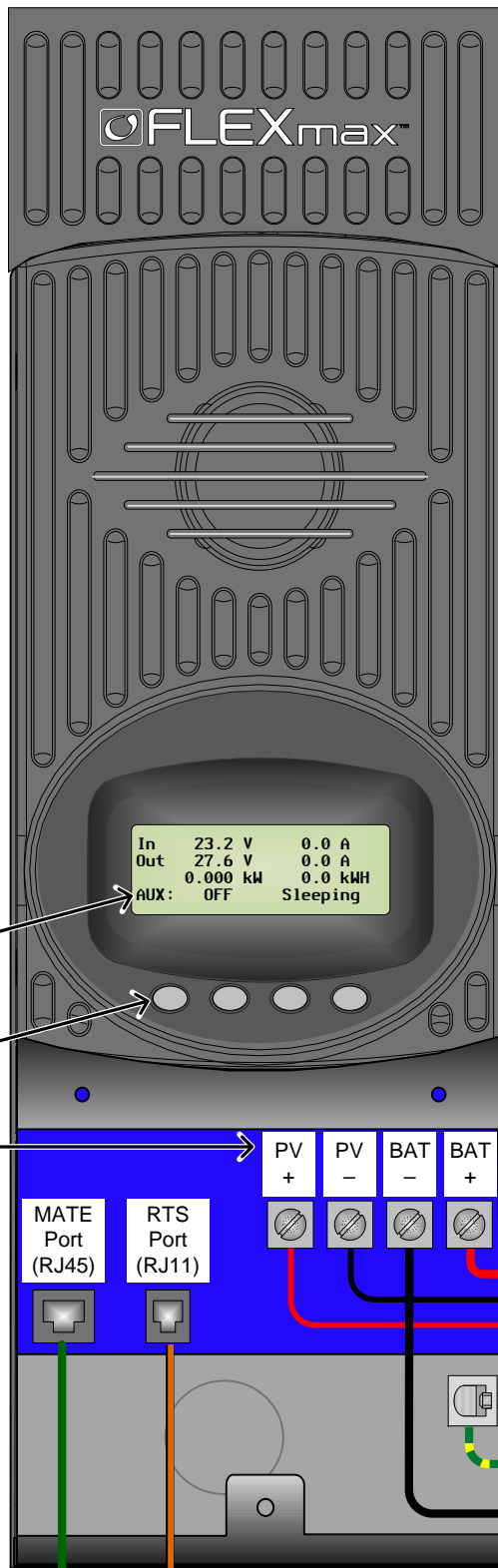

LCD Screen

Soft Keys

Terminals

System Display and Controller (MATE3)

IMPORTANT: Example only. Actual wiring may vary. All configurations must comply with local and national electric codes. Consult your local electric authority to ensure compliance.

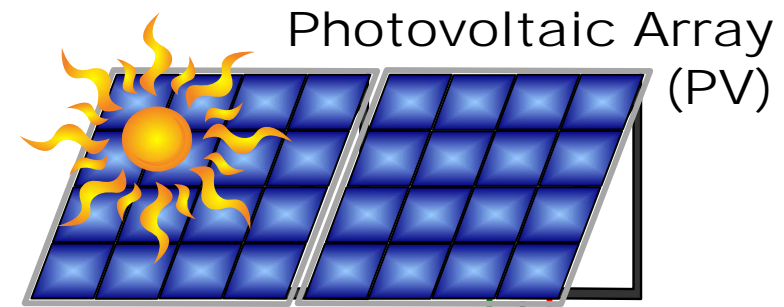

PV Combiner Box

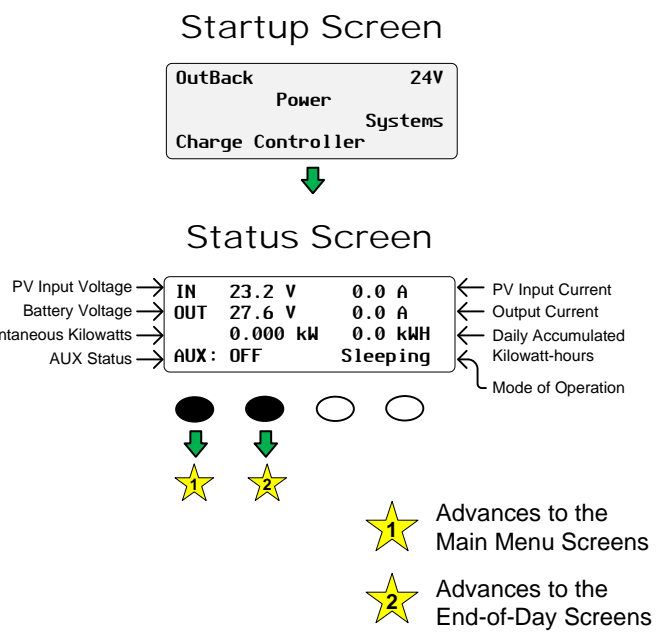
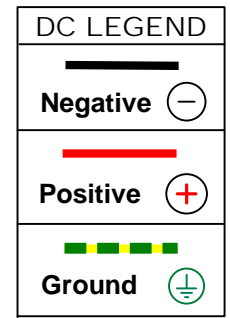
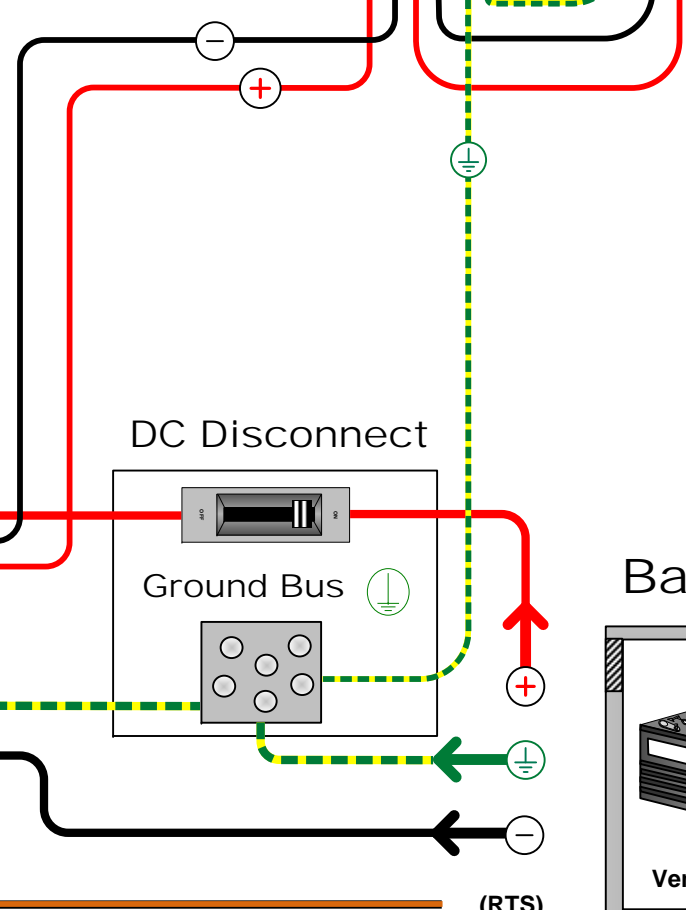
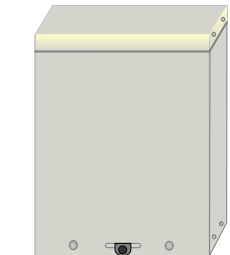

Navigation:

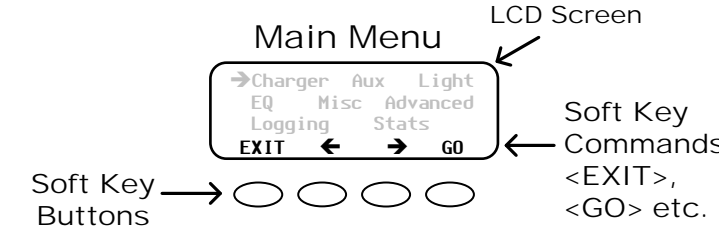

Soft Key Color Code:

- Available menus (Black)
- Select this option to proceed (Green)
- Adjusts the set points value (Yellow)
- Selects a function (e.g., ON, OFF, AUTO) (Orange)
- Switches between devices on the ports of the Communications HUB (Pink)
- Navigation colors (Green, Red, Blue, Cyan)

NOTE: Soft key functions will vary depending on the selected menu and are defined by the word above the key in the LCD.

Indicates a 1-screen movement within a menu. These are color-coded according to their function or purpose.

If accompanied by a dashed line, pressing that soft key will return the user to the location identified by the dashed line. This will vary depending on the devices in the system.

NOTE: See the FLEXmax Series Owner's Manual for details on the settings available in the main menu.

To change the Language, Screen Version or System Voltage:

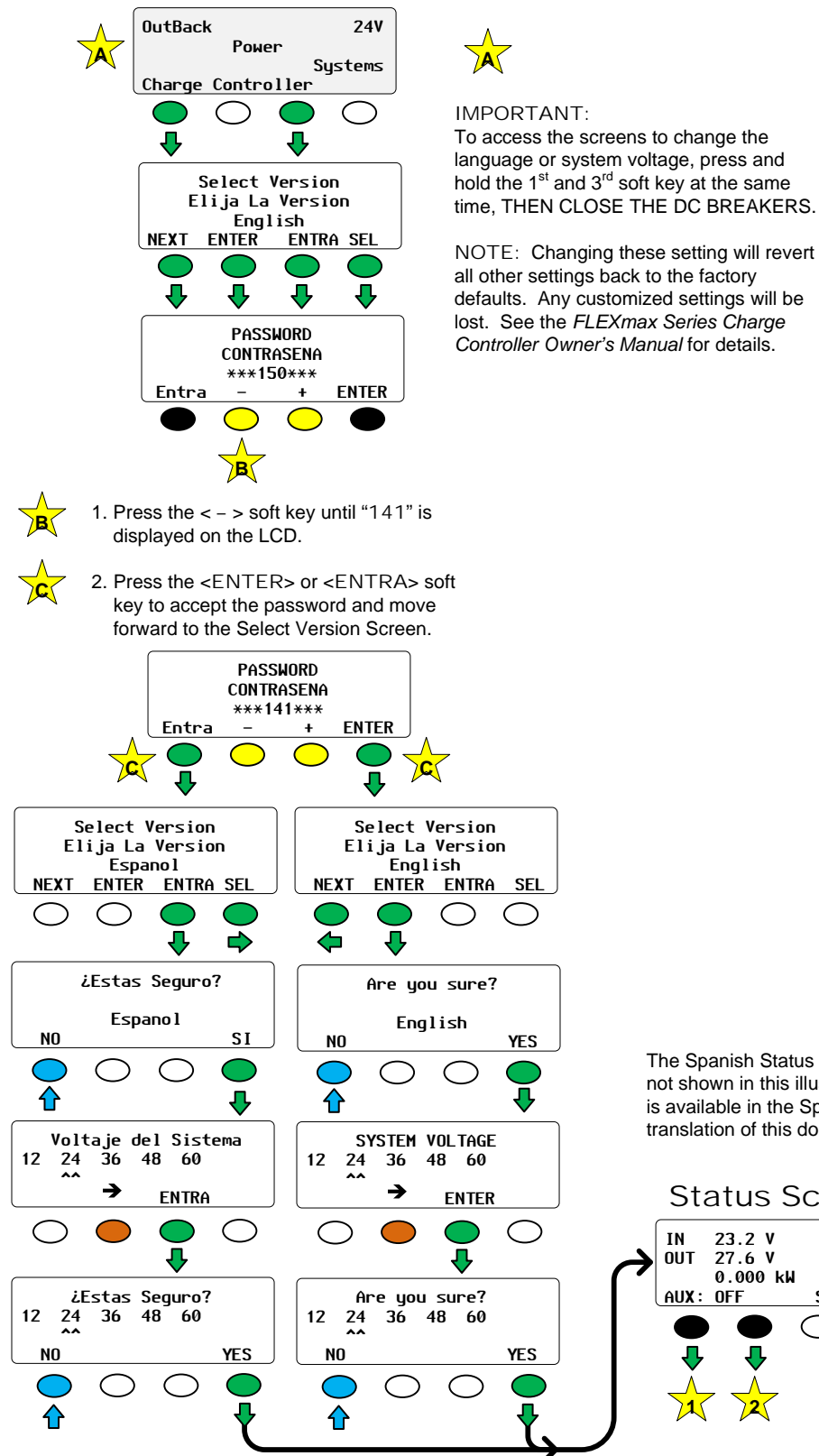

To access the Main Menu:

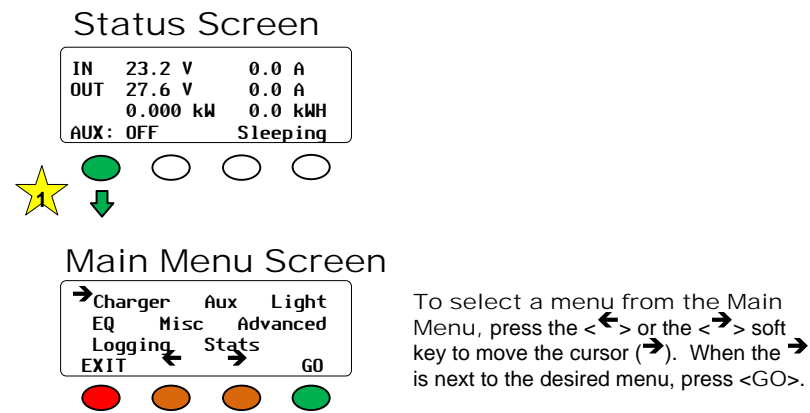

- **Charger**—CHARGER SETUP
Adjusts the Current Limit, Absorbing, and Float recharging voltage set points
- **Aux**—AUX OUTPUT CONTROL
Secondary control circuit for a vent fan, AGS, error alarm, and other system-related additions
- **Light**—BACKLIGHT CONTROL
Adjusts the backlighting of LCD screen and soft key buttons
- **EQ**—BATTERY EQUALIZE
Activates battery equalization (manually or automatically)
- **Misc**—MISCELLANEOUS
Additional settings and service information
- **Advanced**—ADVANCED MENU
Optimizes/fine-tunes the charge controller
- **Logging**—DATA LOGGING
Displays recorded power production information
- **STATS**—STATISTICS
Displays recorded peak system information and cumulative kilowatt-hours and amp-hours

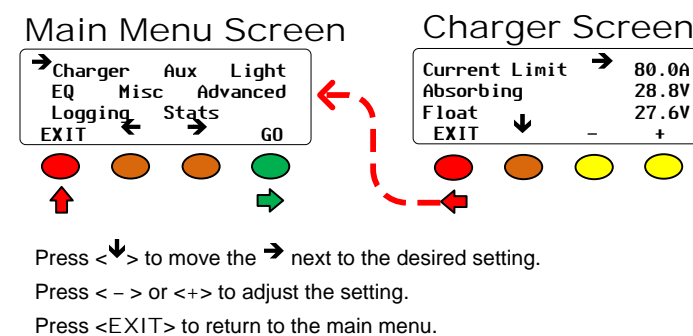

End-of-Day (EOD) Summary Screens

