



Export FX and VFX Series INVERTER/CHARGER Programing Manual

Includes Mounting, Installation, and Product Registration

WARRANTY SUMMARY

Dear OutBack Customer,

Thank you for your purchase of OutBack products. We make every effort to assure our power conversion products will give you long and reliable service for your renewable energy system.

As with any manufactured device, repairs might be needed due to damage, inappropriate use, or unintentional defect. Please note the following guidelines regarding warranty service of OutBack products:

- Any and all warranty repairs must conform to the terms of the warranty.
- All OutBack equipment must be installed according to their accompanying instructions and manuals with specified over-current protection in order to maintain their warranties.
- The customer must return the component(s) to OutBack, securely packaged, properly addressed, and shipping paid. We recommend insuring your package when shipping. Packages that are not securely packaged can sustain additional damage not covered by the warranty or can void warranty repairs.
- There is no allowance or reimbursement for an installer's or user's labor or travel time required to disconnect, service, or reinstall the damaged component(s).
- OutBack will ship the repaired or replacement component(s) prepaid to addresses in the continental United States, where applicable. Shipments outside the U.S. will be sent freight collect.
- In the event of a product malfunction, OutBack cannot bear any responsibility for consequential losses, expenses, or damage to other components.
- Please read the full warranty at the end of this manual for more information.

About Outback Power Systems

OutBack Power Systems is a leader in advanced energy conversion technology. Our products include true sine wave inverterchargers, maximum power point charge controllers, system communication components, as well as breaker panels, breakers, accessories, and assembled systems.

Notice of Copyright

Export FX and VFX Series Inverter/Charger Programming Manual © 2007 All rights reserved.

Disclaimer

UNLESS SPECIFICALLY AGREED TO IN WRITING, OUTBACK POWER SYSTEMS:

(a) MAKES NO WARRANTY AS TO THE ACCURACY, SUFFICIENCY OR SUITABILITY OF ANY TECHNICAL OR OTHER INFORMATION PROVIDED IN ITS MANUALS OR OTHER DOCUMENTATION.

(b) ASSUMES NO RESPONSIBILITY OR LIABILITY FOR LOSS OR DAMAGE, WHETHER DIRECT, INDIRECT, CONSEQUENTIAL OR INCIDENTAL, WHICH MIGHT ARISE OUT OF THE USE OF SUCH INFORMATION. THE USE OF ANY SUCH INFORMATION WILL BE ENTIRELY AT THE USER'S RISK.

Contact Information:

OutBack Power Systems

19009 62nd Ave. NE

Arlington, WA 98223 Phone (360)435-6030 • Fax (360)435-6019 www.outbackpower.com

Date and Revision • September 2007 REV A

TABLE OF CONTENTS

Warranty Summary.....	1
Declaration of Conformity	3
Welcome to the OutBack Power Systems FX Series Inverter/Charger System	4
Safety.....	4
FX Series Inverter/Charger Programming.....	5
Concerns	5
Options.....	5
Components and Connections.....	6
Stacking Options	9
OutBack Parallel.....	9
3-Phase.....	10
Stacking And Assigning FX Status	10
1-2ph Master.....	10
Classic Slave.....	11
OB Slave L1.....	11
OB Slave L2.....	11
3ph Master.....	11
3ph Slave.....	11
Programming the FXs.....	12
1-2 ph Master.....	15
OutBack (OB) Slave.....	15
OutBack (OB) Slave 2.....	16
3-Phase (3ph) Master.....	16
3-Phase (3-ph) Slave.....	17
Introduction to Power Save Levels.....	18
Stacking System Examples.....	22
OutBack Parallel Stacking.....	22
Ranking the Slaves	23
3-Phase Stacking	25
Auxiliary (AUX) Functions.....	26
List of AUX Functions.....	29
Adjustable AUX Output Functions.....	29
Battery Charging Function	32
Maintenance	32
FX Default Values.....	33
Warranty.....	34
Product Registration.....	35

DECLARATION OF CONFORMITY

The OutBack Power Systems FX Series Inverter/Chargers export (“E”) models comply with the EU Declaration of Conformity regarding Electromagnetic Compatibility 89/336/EEC (“Council Directive of 3 May 1989”) and Low Voltage Directive 73/23/EEC (“Council Directive of 19 February 1973”) when installed in off-grid applications only. These inverter/chargers are not to be connected to the mains under any circumstances.

The AC-IN connection on each E model inverter/charger is only approved for connection to an AC generator.

FX Series Inverter/Chargers covered by the EU Declaration of Conformity:

- FX2012ET
- FX2024ET
- FX2348ET
- VFX2612E
- VFX3024E
- VFX3048E

WELCOME TO THE OUTBACK POWER SYSTEMS FX SERIES INVERTER/CHARGER SYSTEM

The FX Series Inverter/Charger offers a complete power conversion system—DC to AC, battery charging, and an AC Transfer Switch—and can be used for stand-alone or back-up applications.

OutBack Power Systems does everything possible to assure the components you purchase will function properly and safely when installed as instructed according to local and national electrical codes. Please read all of the following instructions and the instructions that come with any OutBack components included in your power system. Further instructions on individual FX set-ups as well as systems assemblies are included with the *FX and VFX Series Inverter/Charger Installation Manual*.

The OutBack Power Systems FX and VFX Series Inverter/Charger is ETL listed to UL1741 (Inverters, Converters, Controllers, and Interconnection System Equipment for Use with Distributed Energy Resources). All Mobile FX Series Inverter/Chargers are ETL listed to UL 458

Grounding Instructions

Each FX should be connected to a grounded, permanent wiring system. For most installations, the negative battery conductor should be bonded to the grounding system at one (and only one) point in the DC system. All installations must comply with all national and local codes and ordinances.

The equipment ground is marked with this symbol: 

The *Export FX and VFX Series Inverter/Charger Programming Manual* covers the following information:

- Safety
- Programming or “stacking” multiple FXs using the OutBack Power Systems MATE

IMPORTANT SAFETY INSTRUCTIONS

General Precautions

1. Use caution whenever working around electricity, electrical components, and batteries. There is always a potential for shocks, burns, injury, and even death if an installer or user comes in contact with electricity.
2. Read all instructions and cautionary markings on the FX, the batteries and all appropriate sections of this manual as well as other component manuals before using the system.
3. Be sure each system FX is securely installed according to the *FX and VFX Series Inverter/Charger Installation Manual*.
4. Follow all local and national electrical codes when installing OutBack equipment and components.

FX SERIES INVERTER/CHARGER PROGRAMMING

NOTE: Please see the *FX and VFX Series Inverter/Charger Installation Manual* to install, wire, and connect each FX Series Inverter/Charger. This programming manual assumes all FXs have been installed and are ready to program according to the way they were wired. If a different programming is desired, the FXs might require a different wiring configuration (see sample wiring diagrams in the *FX and VFX Series Inverter/Charger Installation Manual*). To familiarize yourself with the programming concepts, please read through the entire manual before programming your system.

Up to ten off-grid FXs or three FXs in a three-phase system can be combined and wired or “stacked” for systems requiring more power. A user’s final loads and power needs determine which stacking configuration will work best.

- Stacking FXs does not refer to physically placing one FX on top of another, but to how they are wired within the system and then programmed for operation. Stacking allows all the FXs to work together as a single system.
- Stacking assigns the FXs to power individual legs of the system and to operate at certain times; this order is assigned using the MATE.
- **NOTE:** An OutBack MATE is required to recognize and program the FXs. When multiple FXs are used, each needs to be assigned a status—Master or Slave.
- The Master FX is the primary and most heavily used unit. The loads and demands of the system determine when and which Slaves are used. A Slave FX assists when the load demands are more than the Master FX can handle alone.
- This is an orderly process as long as the user assigns each FX correctly. It is mainly a matter of paying attention to the Port number for each FX when programming with the MATE.

Stacking Concerns

FXs should be wired and stacked appropriately to their individual power system. Problems can occur when:

- An FX is incorrectly wired.
- An FX plugged into a HUB Port is mistakenly programmed (assigned the wrong status) or misidentified.
- ***An easy rule to remember is any FX wired to a specific phase or leg must be programmed to that phase.***

Stacking Options

The export FX and VFX Series Inverter/Chargers can be stacked in the following configurations (see page 9).

1. OutBack Parallel
2. 3-Phase

Each stacking option has benefits and should be chosen according to a user’s needs and individual power system. Consult with your dealer or installer to determine what will work best for you.

COMPONENTS AND CONNECTIONS:

1. With all AC and DC breakers OFF, connect all FXs to the HUB with individual lengths of CAT5 cable.

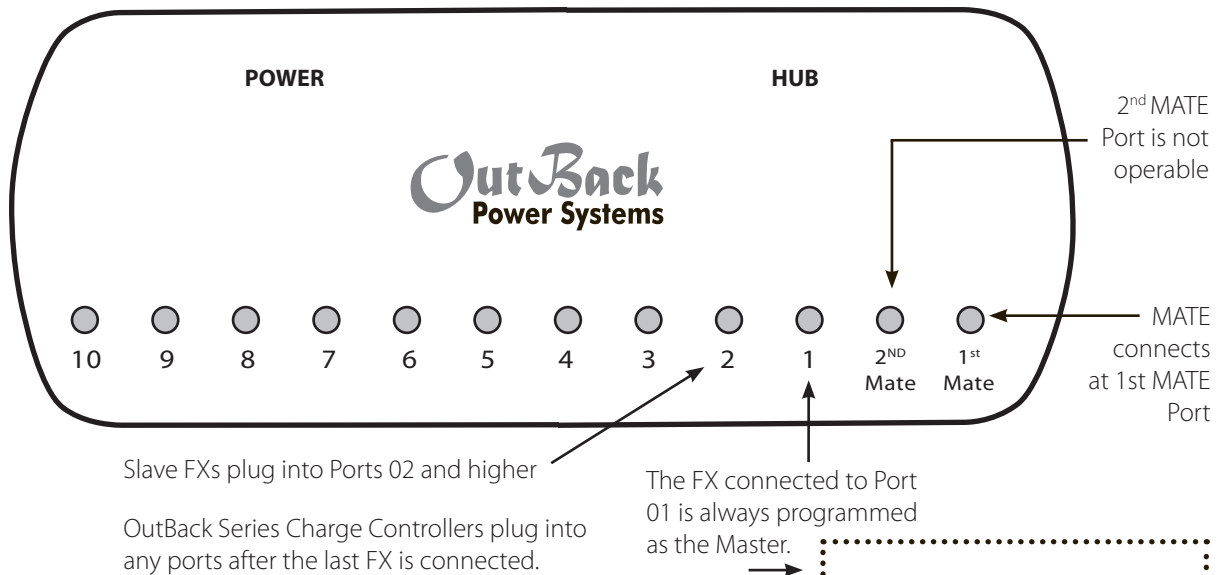
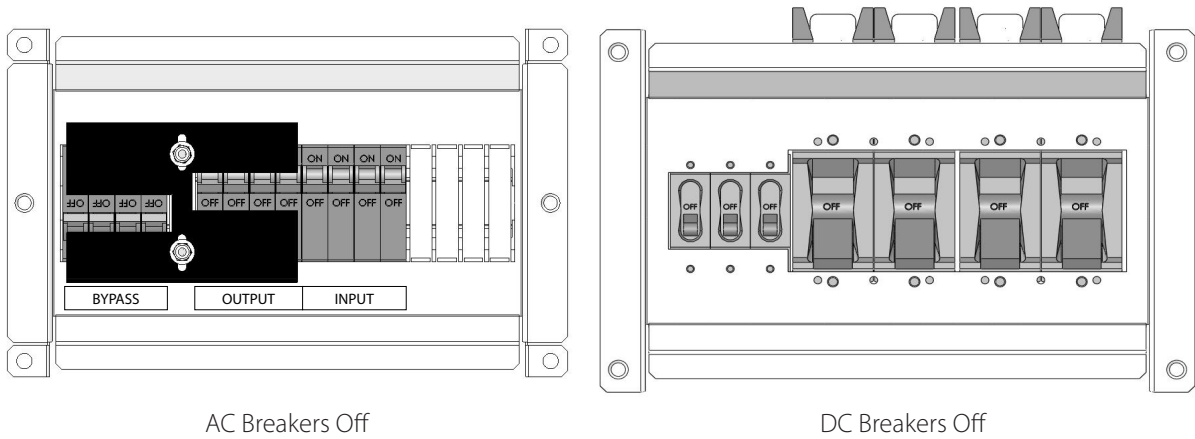

- Connect the OutBack MATE after all other components, including any OutBack Charge Controllers, have been connected and powered up.
- Components installed after powering up the system will require repolling the MATE (please see page 8).
- With the MATE, a user assigns a status and stacking value to the FX on each Port. These status and value assignments can be changed at anytime as long as the Master FX is plugged into HUB Port 01.

- "1-2ph Master" for one and two-phase systems
- "3ph Master" for a 3-phase system
- The Master FX is always considered to be the leg one phase.

NOTE: Pay attention to the Port number on the screen! Be sure the FX whose status and stacking value you're changing is the one you mean to change.

2. With the FXs connected to the HUB, turn only the DC breakers ON and power up the components. All AC breakers should be OFF.

NOTE: For 3-phase stacking, the jumper in the HUB must be set to the 3-ph position. See the HUB User Manual for further information.

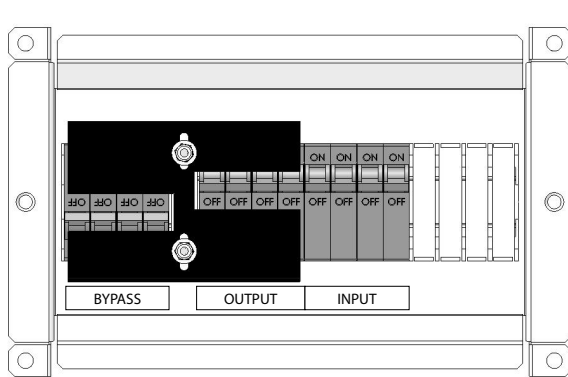

AC Breakers Off

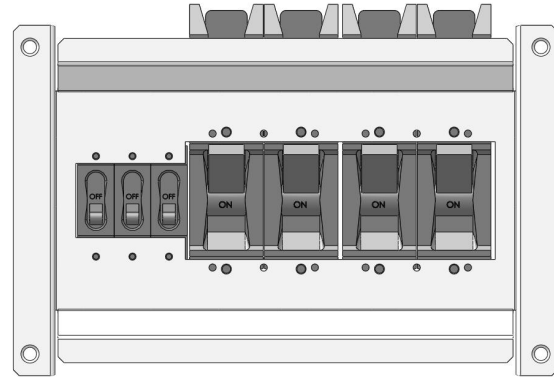

DC Breakers On

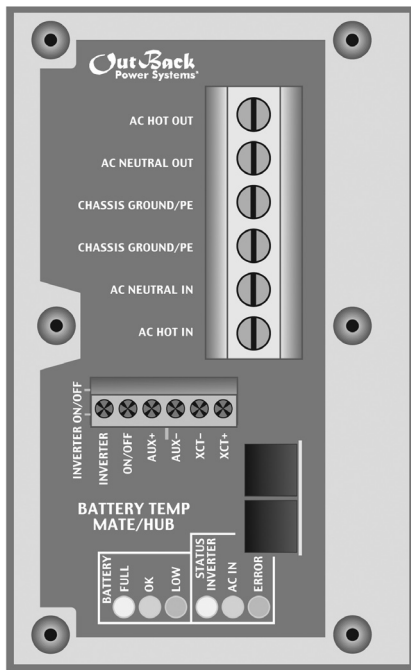

LED Color	LED Action	LED Indicates
Green	Solid GREEN →	Inverter ON
	Flashing GREEN →	Search Mode Standby
	Off →	Inverter OFF
Yellow	Solid YELLOW →	AC Source is Connected
	Flashing YELLOW →	AC Input Live-Waiting to Connect to the FX
	Off →	No AC Input Present
Red	Solid RED →	Error-Error Message, displays on the MATE
	Flashing RED →	Warning: Non-critical FX fault, the MATE can access this information

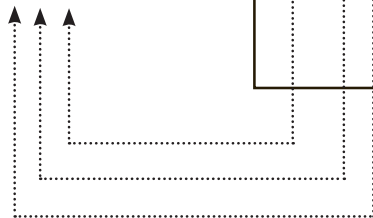

NOTE: Powering up the FXs can cause the red ERROR STATUS light to blink. After 5-10 seconds, the green INVERTER light should be bright and the ERROR and AC IN lights dark. The FX is now producing AC output voltage.

3. After powering up the components, connect the MATE to the HUB.

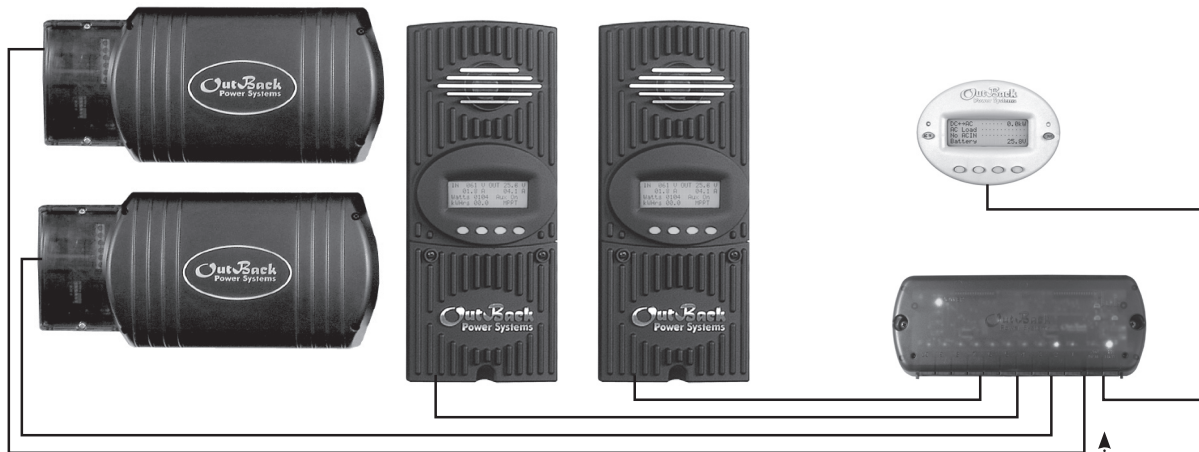

- Plug the MATE into the 1st MATE Port on the HUB:
- The MATE will power up and should recognize any component connected to the HUB.
- The MATE can then program the FXs.
- The fifth MATE screen ("Port Assignment") should display all the FXs and any OutBack Charge Controllers in the system.

MATE Screens

PATH	→	→	→	→
G'day Mate	(C) 2007 OutBack Power Systems	Version Code a.aa Serial #xxxxxxx Screen EE b.bb	Searching for Devices HUB Found	Port Assignment 1> FX 2> FX 3> CC 4> CC 5> 6> 7> 8> 9> 10> 2M>

4. To verify the MATE recognizes each HUB connected FX and OutBack Charge Controller, disconnect and then either (a) reconnect the MATE to view its boot-up and repoll sequence or (b) follow this path to manually repoll:

PATH	→	→	→	→
MAIN----- 12.15:30p	SETUP----- choose device:	SETUP/MATE/PAGE1 mate code rev: 402 choose category:	SETUP/MATE/PAGE2 choose category:	SETUP/MATE/COMM choose category:
SUM STATUS SETUP ADV	FX MATE	CLOCK CNT GLOW PG2	PG1 SUMRY COMM PG3	BACK REPOLL PC DEBUG



The FXs are now ready to be programmed according to the stacking options described in the next section.

STACKING OPTIONS

OutBack Export FXs can be stacked in one of two configurations:

1. OutBack Parallel
2. 3-Phase

NOTE: Although stacking 10 FXs is possible, OutBack's AC hardware only accommodates configurations of two, four, or eight FXs. A system with eight FXs would require two AC Input/Output Bypass (IOB) Breaker Kits or installing an external manual bypass; ten FXs would require three IOB kits or an external manual bypass.

1. Outback Parallel

- 2-10 FXs are wired to the same 230 VAC output leg or phase.
- The Slave FXs can be programmed to remain at different power levels ("Silent" or "On" depending on the need) to save energy; the Slaves will come on when the power demand requires them.
- This power-saving system is fully automatic and works with or without a MATE connected to the system, although a MATE is required to program the components. Without a MATE, the user cannot reprogram.
- The AC input (generator or grid) must be 230 VAC.



2. 3-Phase

- Three—and only three— FXs are connected, one to each of three 230 VAC output legs that produce 400 VAC between any two legs of the system.
- The HUB requires a jumper between the two Slave FXs for this stacking to function (see HUB Manual).
- The AC input source (generator or grid) must be a 230 VAC/400 VAC 3-phase source.

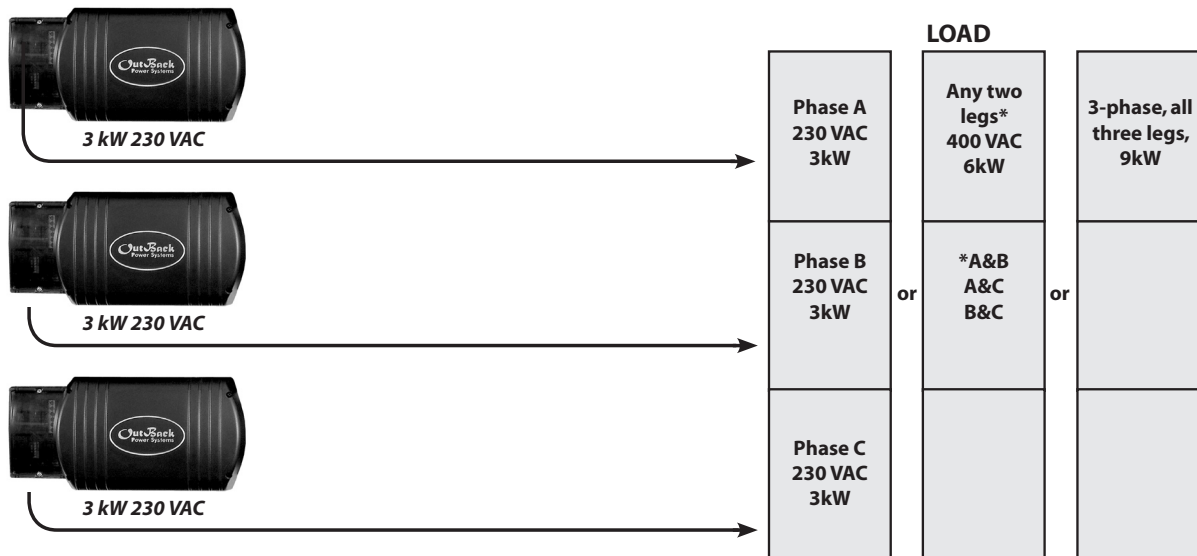

STACKING AND ASSIGNING FX STATUS

Use the MATE to establish the order or hierarchy of all the system FXs by designating each as one of the following:

- 1-2ph Master (OutBack Parallel, OutBack Series, or Classic Series stacking)
- Classic Slave (Classic Series stacking)
- OB (OutBack) Slave L1 (OutBack Parallel, OutBack Series, or OutBack Series/Parallel stacking)
- OB (OutBack) Slave L2 (OutBack Series or OutBack Series/Parallel stacking)
- 3ph Master (3-Phase stacking)
- 3ph Slave (3-Phase stacking)

NOTE: Some stacking options that appear on the MATE should not be used with an Export FX or VFX and are marked as such in the text.

1. 1-2ph Master

- This is the default ranking of every FX. It applies to one-phase and two-phase systems.
- One Master FX is established for every multiple FX system.

2. Classic Slave

- Classic Slave is the designation of the second FX in a two-inverter, split-phase system that produces 400 VAC without using an FW-X240 Auto Transformer.
- This FX is plugged into Port 02 of the HUB.

This stacking option is not to be used in the Export FX or Export VFX.

OB Slave L1 and OB Slave L2 designations are used in OutBack Parallel Stacking or OutBack Series/Parallel stacking

3. OB Slave L1

- In an OutBack Parallel single phase system, all the Slave FXs on a single 230 VAC leg are designated OB Slave L1.
- In an OutBack Series split phase system, which will include an FW-X240 or PSX-240 Auto Transformer, any FX that runs in parallel to the Master FX is designated OB Slave L1. These FXs must be plugged into the lowest HUB Ports. This stacking option is not to be used in the Export FX or Export VFX.
- The OB Slave L1 Stacking is typically used for an entirely off-grid application such as a cabin that does not require 400 volts.

4. OB Slave L2

- In an OutBack Series split phase system, any Slave FX that runs in series with the Master FX is designated OB Slave L2.

This stacking option is not to be used in the Export FX or Export VFX.

5. 3ph Master

- In 3-Phase stacking, the Master FX is designated as 3ph Master.
- 3ph Master and 3ph Slave designation are used in OutBack 3-Phase stacking.

6. 3ph Slave

- In 3-Phase stacking, each of the Slave FXs, which should be plugged into HUB Ports 02 (phase B) and 03 (phase C) respectively, is designated as 3ph Slave.
- When the HUB jumper is set between Port 02 and Port 03, the HUB identifies a phase for each Slave FX.

Stacking Phases/Assigning FX Status (in order):

1. 1-2ph Master
2. Classic Slave
3. OB Slave L1
4. OB Slave L-2
5. 3ph Master
6. 3ph Slave

PROGRAMMING THE FXs

Once the MATE recognizes each FX (and OutBack Charge Controller), push and hold the first two soft keys simultaneously to return to the MAIN menu. To program the FXs, go to the ADV/FX/STACK menu on the MATE navigating with the following steps:

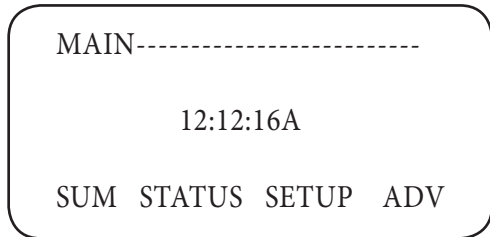

- Press the **<ADV>** soft key.

NOTE: Pressing and holding the first two soft keys at the same time will always bring up the Main Menu screen.

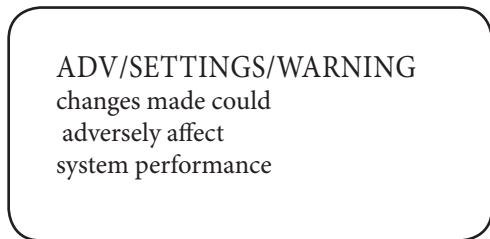

- Push any soft key on the ADV/SETTINGS/WARNING screen and go to the ADV/PASSWORD screen.

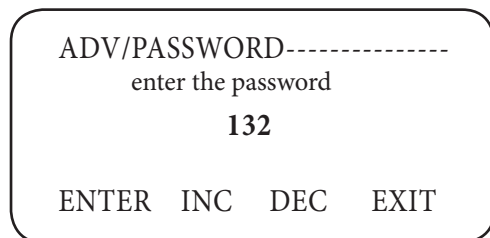

- The screen displays <132>. Press the **<INC>** button until it scrolls to the password 141.

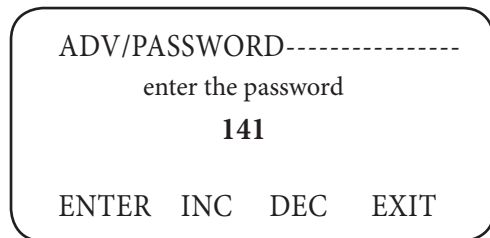

- Push the **<ENTER>** soft key.

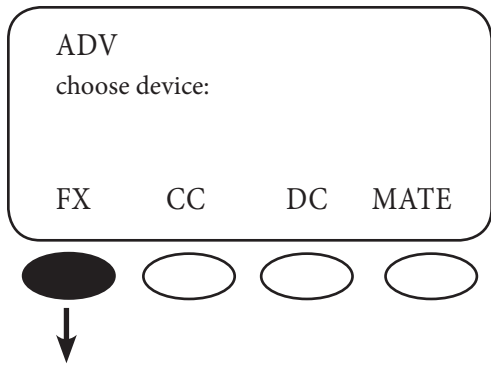

- In the ADV menu, press the **<FX>** soft key.

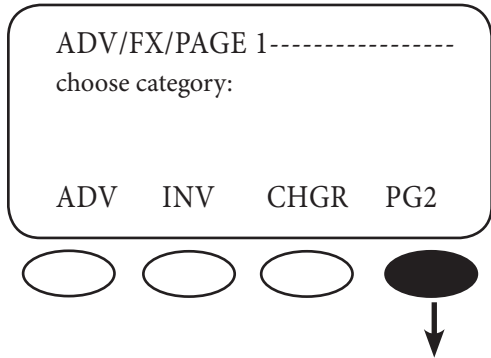

- On the ADV/FX/PAGE 1 screen, press the **<PG2>** soft key and go to the ADV/FX/PAGE2 screen.

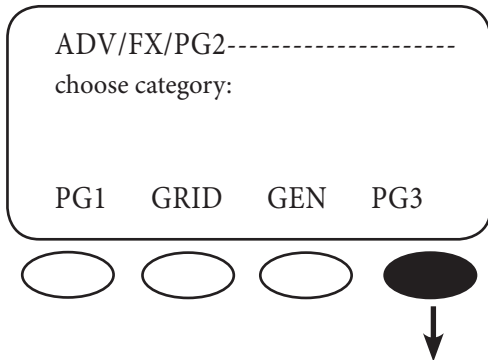

- Press the **<PG3>** soft key which leads to the ADV/FX/PAGE3 screen.

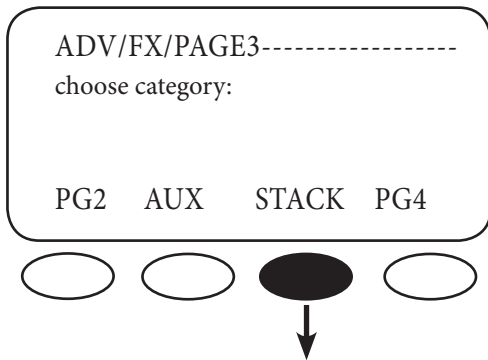

- On the ADV/FX/PAGE3 screen, press the **<STACK>** soft key.

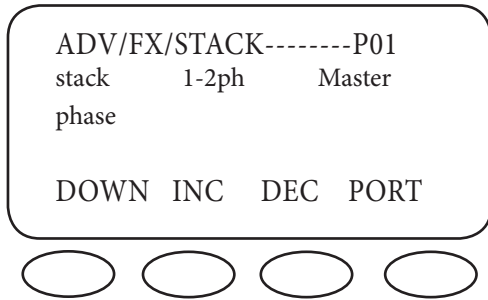

- Stacking the FX Series Inverter/Chargers begins on this screen. See specific stacking procedures in the next section.

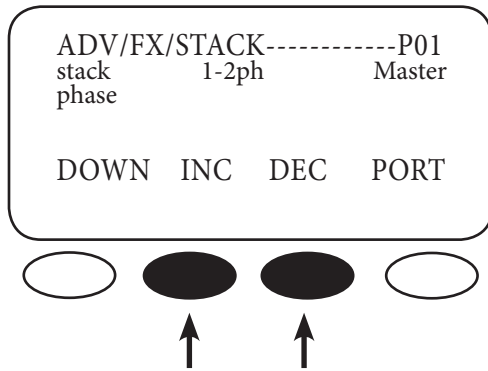

← Port 01 always takes the Master FX.

← Pressing the **<PORT>** soft key changes the HUB Port whose value you wish to adjust.

↑ ↑
 Pressing the **<INC>** or **<DEC>** soft keys changes the stacking phase.

1-2PH MASTER

With the Port 01 FX as the Master, press the **<PORT>** soft key to change the remaining Ports and designate the remaining FXs as Slaves. The MATE screen for Port 02 will look like this:

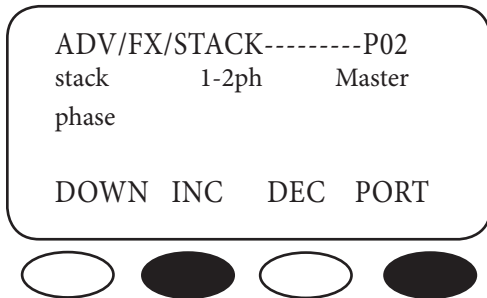

- The MATE is now ready to program the FX plugged into Port 2 of the HUB.
- 1-2ph Master is the factory default value for each FX.

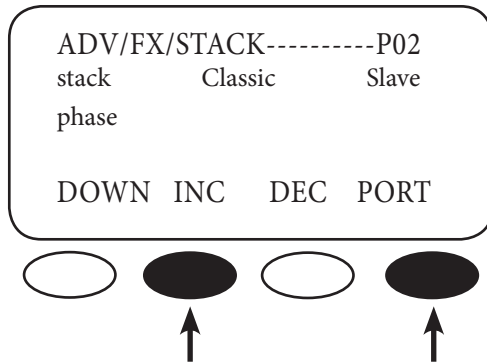

- Pressing the **<INC>** soft key will keep the MATE's attention on Port 2, but will change the stack phase to Classic Slave screen. Port 02 will then be assigned as a Classic slave. You can change the stacking phase by pressing the **<INC>** or **<DEC>** soft keys and change to a different Port by continuously pushing the **<PORT>** soft key.

NOTE: There are no **<OK>** or **<DONE>** commands in the stacking menu. Whichever value—Master or Slave—shows up on the MATE screen will be assigned to the chosen Port (and FX) upon leaving that screen. It's important to watch the Port number in the top right corner of each screen to be sure you've assigned it the desired status.

OUTBACK (OB) SLAVE

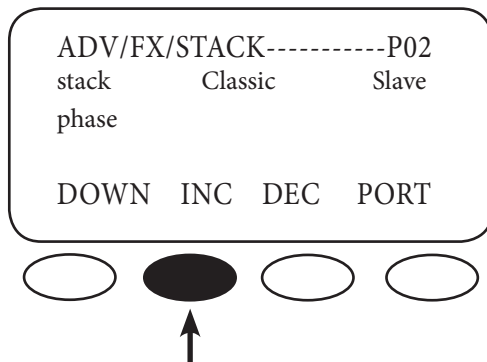

- Systems with two to ten FXs call for OutBack Slave Stacking. Press the **<INC>** soft key in the ADV/FX/STACK screen to change the stack phase from Classic Slave to OB Slave L1.

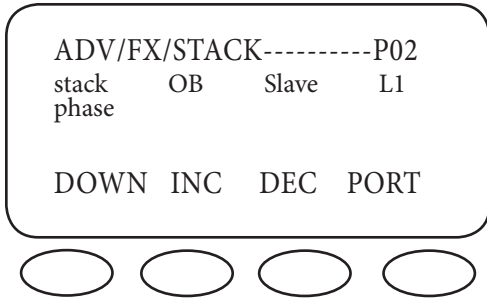

- OB Slave 1 stacking phase

OUTBACK (OB) SLAVE L2

- Set the FXs you want as series slaves (Leg 2) to OB Slave L2.
- This FX is considered the L2 phase.

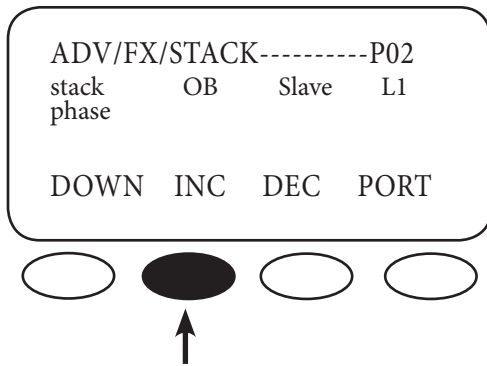

- To use OutBack Slave L2 Stacking, press the **<INC>** soft key in the ADV/FX/STACK OB screen to change the stack phase from OB Slave L1 to OB Slave L2.

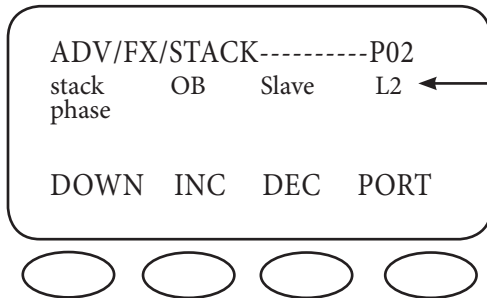

- The FX assigned to Port 02 now has OB Slave L2 status.

3-PHASE (3PH) MASTER

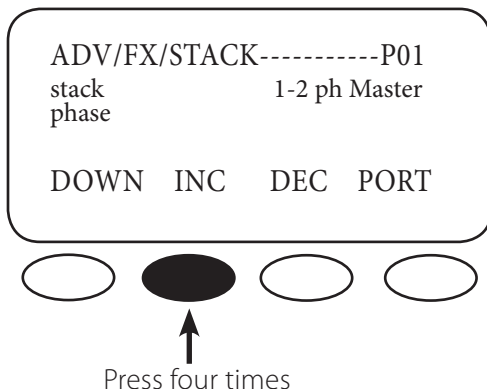

- A 3-phase system with only three FXs requires one of two different stacking procedures. Starting from the first stacking menu—ADV/FX/STACK—press the **<INC>** soft key four times.

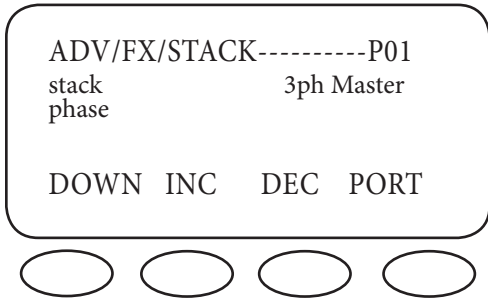

The FX has now been set to 3ph Master status.

3-PHASE (3-PH) SLAVE

- Set the two Slave FXs to 3ph Slave and make sure they are in Ports 02 and 03 of the HUB.
- There are no selections to differentiate between phases B and C.
- When you set the jumper in the HUB for 3-phase, the HUB assigns each Slave to its phase. 3ph Slave on HUB Port 2 is considered phase B.
- 3ph Slave on HUB Port 3 is considered phase C.

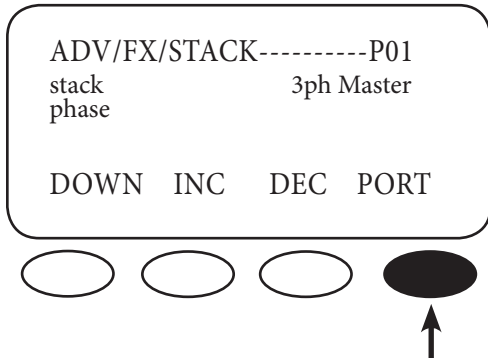

- From the 3-ph Master screen, press the **<PORT>** soft key until P02 appears.

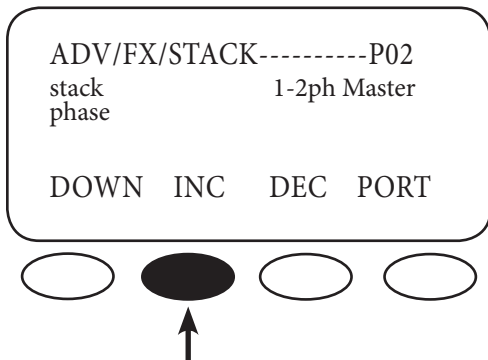

- Each new Port screen in the stacking menu will open with 1-2ph Master displayed. To change the stacking designation, press the **<INC>** soft key until 3ph Slave appears.

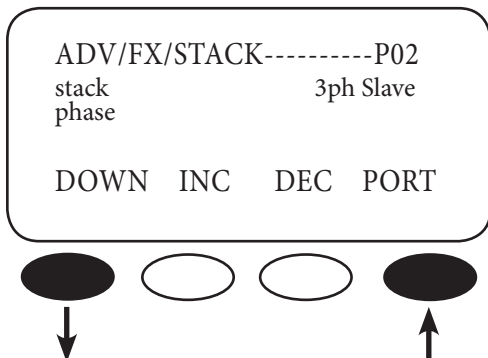

- After establishing P02 as a 3ph Slave, move onto P03 and repeat the procedure. Press the **<DOWN>** soft key when finished.

INTRODUCTION TO POWER SAVE LEVELS

Depending on the model, each FX consumes 20-25 watts of power when it remains on, even if it isn't actively inverting or charging. OutBack Power Systems offers the option to shut down (put into Silent mode) some or all of the Slave FXs until the loads require them to come on again.

- When a load exceeds 12 amps AC, the Master FX shares the load with one or more Slave FXs.
- When the Master detects only a four amp load, a Slave FX goes into Silent mode; Slaves will continue to go into Silent mode as long as the Master detects four amps.

The next two screens in the MATE's Stack menu adjust the power levels of the Master and Slave FXs. From any STACK PHASE screen:

- Press the **<DOWN>** soft key once to bring up the power save level master adjust only screen
- Press the **<DOWN>** soft key again to bring up the power save level slave adjust only screen

NOTE: These power save level master adjust only and power save level slave adjust only screens pertain to systems that have OB Slave L1 and/or OB Slave L2 type slaves only.

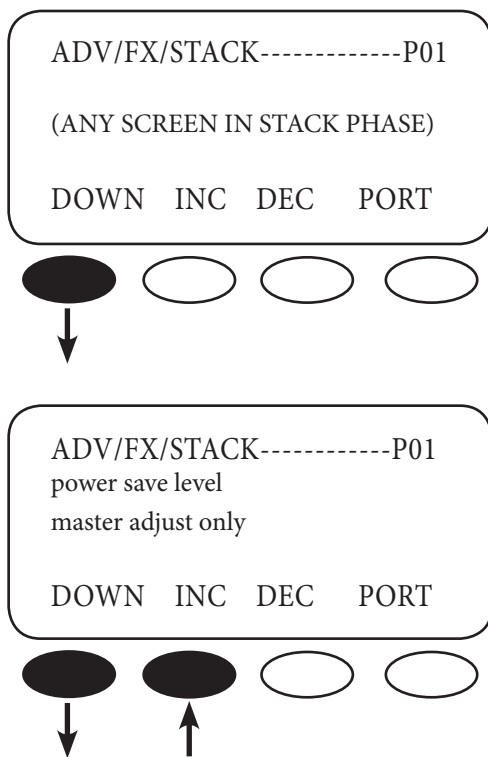

- Press the **<DOWN>** soft key once.

- Press the **<INC>** soft key to increase the power save level master adjust only value. Any Slave with this value or lower, which is assigned in the power save level slave adjust only screen (next), will be on with the Master. If the power save level master adjust only is three, for instance, any Slave assigned a value of 3 or lower will be on when the Master is on. Since the Master is essentially always ON, these Slaves will always be on as well. Any Slave with a value of 4 and higher will be Silent until the Master activates them for larger loads. For days of the week with small load demands, a user can decrease the power save level master adjust only value so fewer FXs are running.

- The default value is zero (only the Master is on).
- Press **<DOWN>** to view the power save level slave adjust only screen.

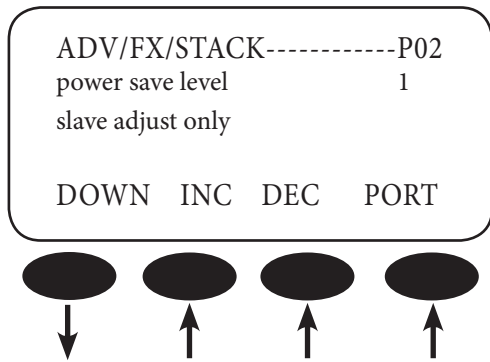

The default value for the power save level slave adjust only screen is 1. Press the **<INC>** or **<DEC>** soft keys to adjust this value. Press the **<PORT>** soft key to change the value of each Slave FX.

- The Slave(s) must be connected to Port 2 or higher on the HUB.
- With the Master FX default value of zero in the power save level master adjust only screen, all of the Slave FX's will remain OFF until the Master FX needs help and calls for the Slave FXs with "Slave Rank" equal to 1 to come ON.
- Choose a different "Slave Rank" for each Slave FX. This helps assure proper operation and allows them to come ON one at a time saving power in the long run. Otherwise, with a default value of 1 for all Slaves, they will all come on whenever a 12 amp load calls for more power, but then can quickly shut off because multiple FXs provide far more than the required 12 amps. Ranking them 1, 2, 3, 4 etc. means they will come on one at a time as needed to better serve the loads and conserve energy.
- Press the **<DOWN>** soft key to view the final stacking screen.

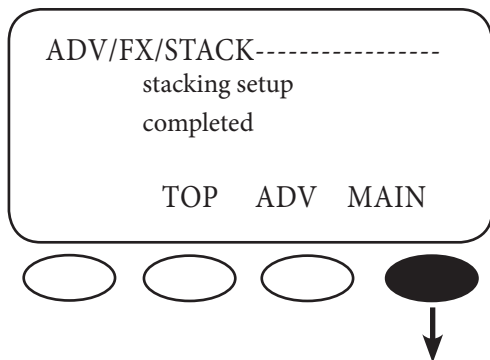

- Press the **<MAIN>** soft key to return to the Main Menu.

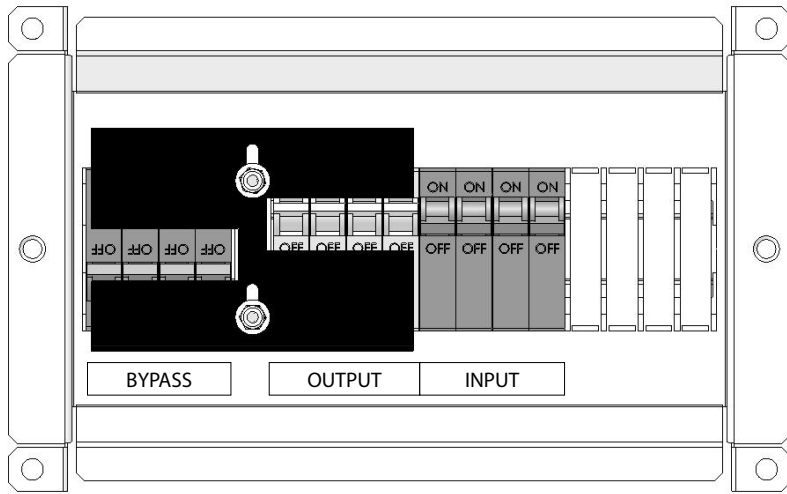

- With the programming completed, turn the AC output breakers ON with the AC BYPASS on the AC breaker panel switched to NORMAL.

NOTE: If you are doing OutBack Stacking, turn on the FW-X240 Auto Transformer breaker now. Otherwise, go to the next step.

- Verify the AC voltage output through the MATE following path:

Verify the AC voltage output with the MATE:

PATH	→	→	→	
MAIN----- 12.15:30p	SETUP----- choose device:	STATUS/FX/PAGE1----- choose category:	Float P00 inv 0.0Kw zer 0.0kw chg 0.0kw buy 0.0kw	STATUS/FX/METER—P00 output 230 vac voltage
SUM STATUS SETUP ADV	FX CC DC MAIN	MODES METER BATT PG2	DOWN STATUS PORT	DOWN UP TOP PORT



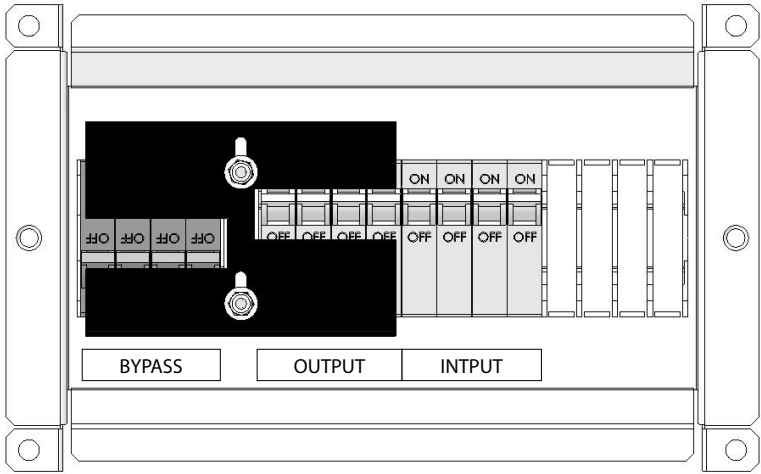

- Turn the AC input breakers ON.

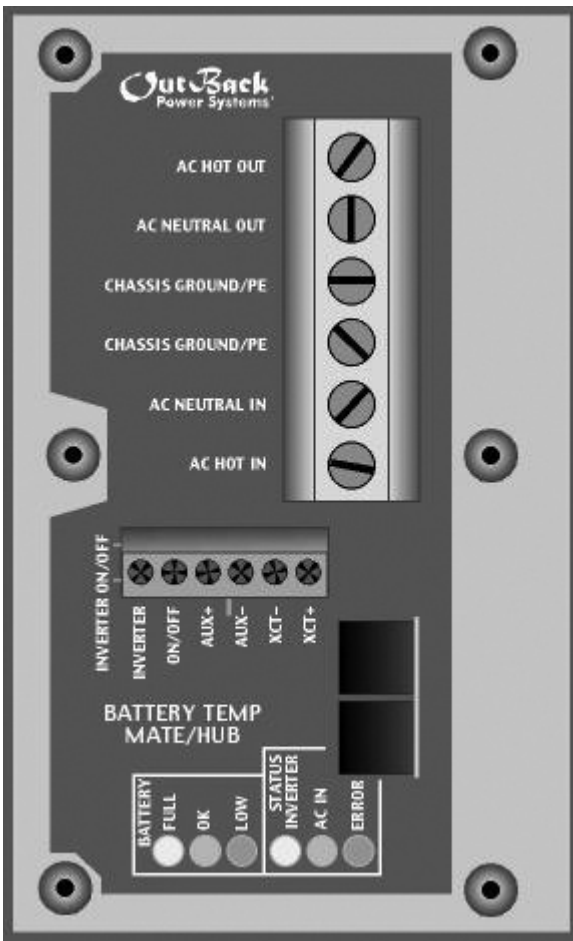

If the FX's AC source is available, the yellow AC IN STATUS light will blink. The FX will connect to the utility grid when the voltage is within 200-260 VAC and the frequency between 45-55 Hz. After about 30 seconds, the AC IN light should stop blinking and stay lit. The FX will now perform a battery charge using the available AC.

STACKING SYSTEM EXAMPLES

OutBack Parallel Stacking

- Four FXs in a single system are referred to as a Quad Stack.
- The FX installed at the bottom of the stack is plugged into Port 1 of the HUB.
- The second, third, and fourth FXs are plugged into Ports 2, 3, and 4 respectively.

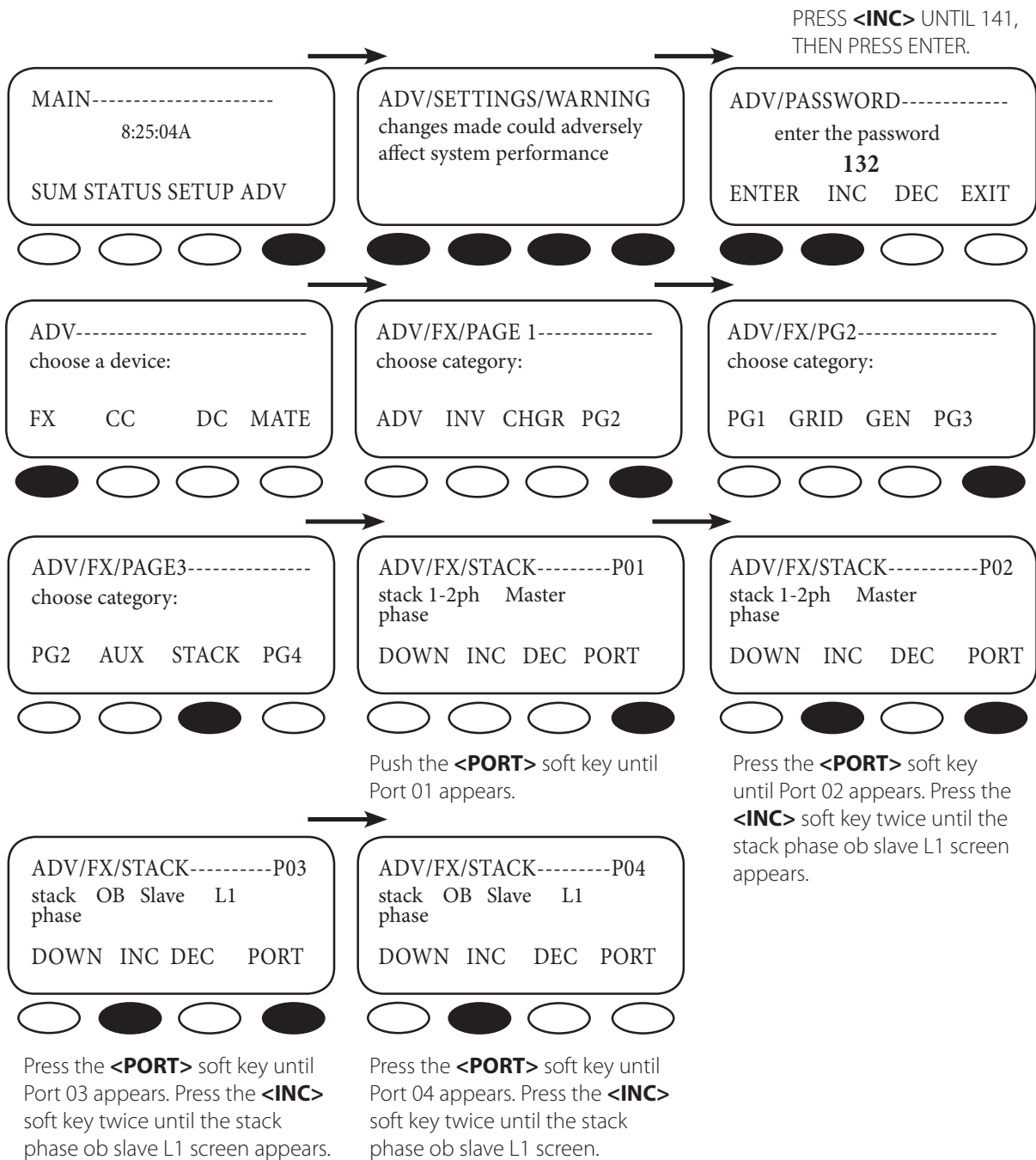

At completion, each Slave FX in Ports 2, 3, and 4 will be in parallel with the Master in Port 01. Additional Slaves can also be programmed as "OB Slave L1" following the instructions above. All the Slave FXs connected to Ports 2, 3, and 4 are now in parallel with the Master in Port 01. Remain in this screen. The next step is to rank the Slaves in relation to the Master.

RANKING THE SLAVES

- Start from the last ADV/FX/STACK screen.

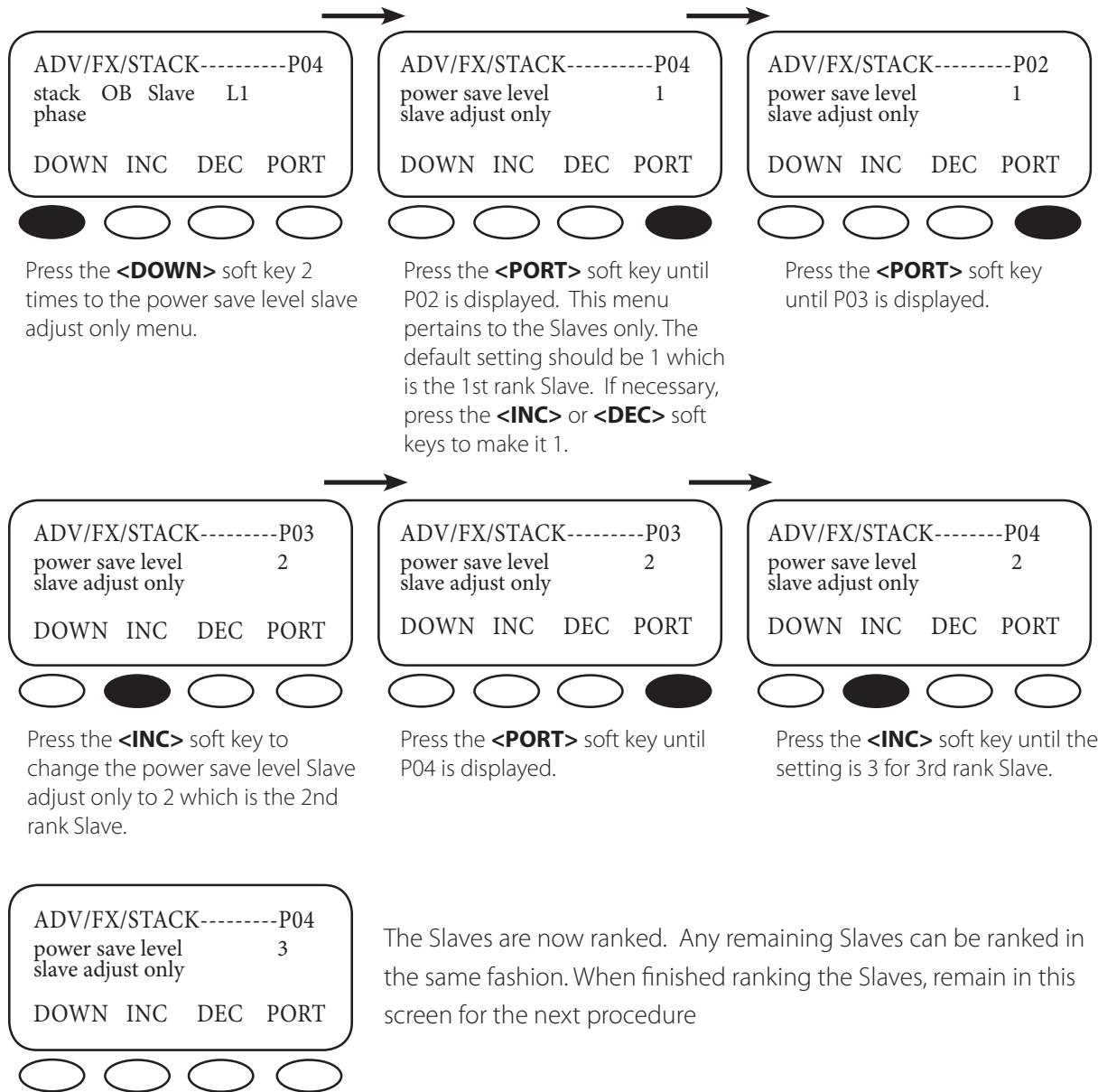

After setting up your OutBack Parallel Stacking and establishing the Master and Slave order, shut off all the AC input and output breakers and check your system via the following MATE screens:

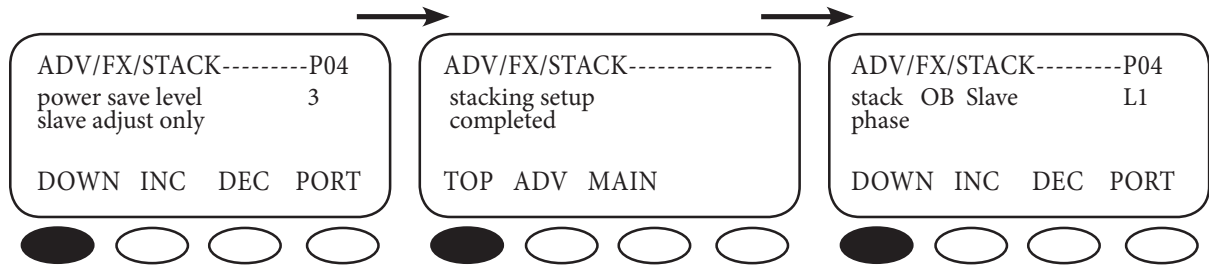

From the ADV/FX/STACK power save level slave adjust only screen, press the **<DOWN>** soft key, the **<TOP>** soft key, and then the **<DOWN>** soft key.

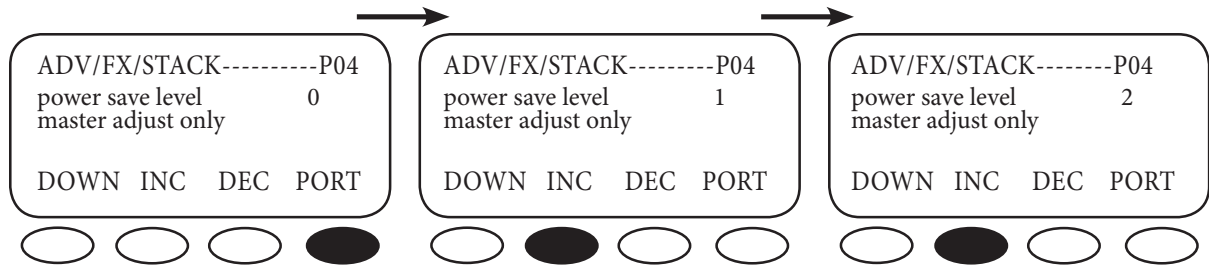

Verify this is the power save level master adjust only screen. Press the **<PORT>** soft key until P01 appears on the screen. Turn on all of your FX AC Output breakers. The Master FX's "INVERTER" LED should be solid and all the Slaves "INVERTER" LED's should be blinking.

Press the **<INC>** soft key to adjust the power save level master adjust only from 0 to 1 and watch the 1st Slave's "INVERTER" LED go solid. When the "INVERTER" LED is on solid, this means that the inverter is on. When the "INVERTER" LED on the Slave is blinking, this means the FX is asleep.

Press the **<INC>** soft key once to adjust the power save level master adjust only to 2 and watch the 2nd Slave's "INVERTER" LED turn on

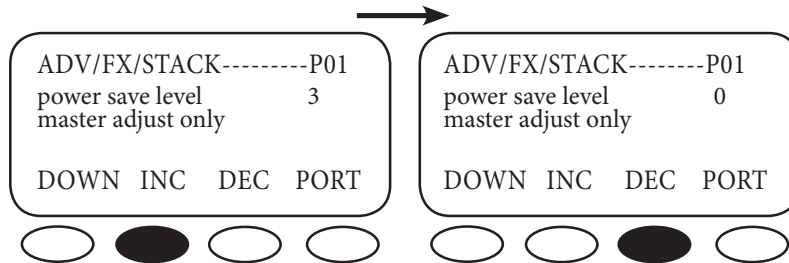

Press the **<INC>** soft key once to adjust the power save level master adjust only to 3 and watch the 3rd Slave's "INVERTER" LED turn on. If the system has more than three Slaves, keep increasing the value in the power save level master adjust only screen and verify that each Slave's "INVERTER" LED comes on as expected. This check verifies all FXs are stacked correctly.

Adjust the power save level master adjust only to 0 by pressing the **<DEC>** soft key.

3-Phase Stacking (Three FX Series Inverter/Chargers Only)

A 3-phase stacked system with only three FXs must be set up as described here:

- Turn off all AC output and AC input breakers before powering up FXs.
- Plug the top FX into Port 01 of the HUB, the 2nd FX into Port 02, and the 3rd FX into Port 03.
- Change the HUB jumper for 3-phase stacking (refer to the HUB manual).
- Go to the first MATE stacking menu ("Stack Phase") press the **<PORT>** soft key until Port 01 appears.
- Set the "Stack Phase" of the Port 01 FX to "3ph Master" by pressing the **<INC>** soft key. The Master FX is considered phase A.
- Press the **<PORT>** soft key and verify P02 (2nd FX) displays.
- Press the **<INC>** soft key five times to set the "Stack Phase" to "3ph Slave."The P02 FX is now set as phase B, producing 400VAC between itself and the Master (P01).
- Press the **<PORT>** soft key again and verify P03 (3rd FX) is displayed.
- Push the **<INC>** soft key five times to set the "Stack Phase" to "3ph Slave". This FX (P03) is now set as phase C, producing 400VAC between itself and the master (P01) and also 400VAC between itself and the FX on phase B.

NOTE: The AC input to a 3-phase system must be a 3-phase source (generator or grid).

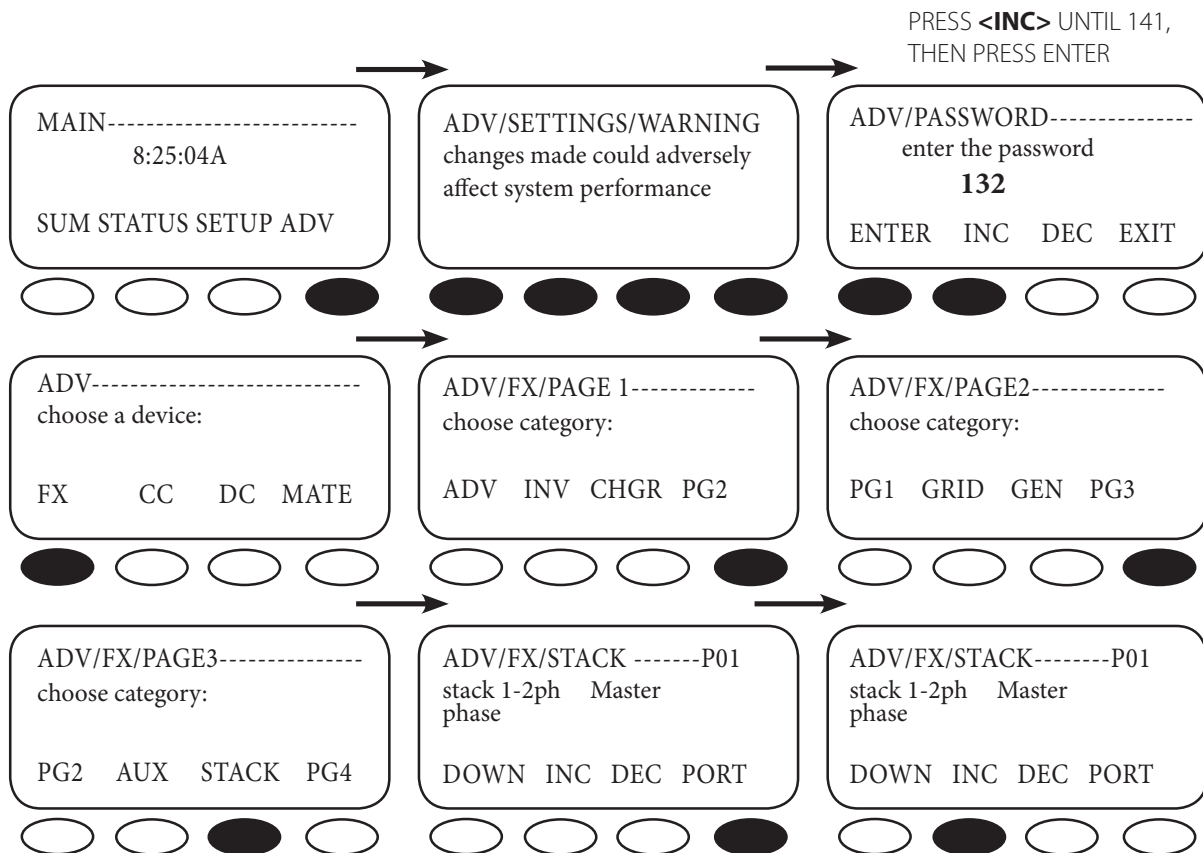

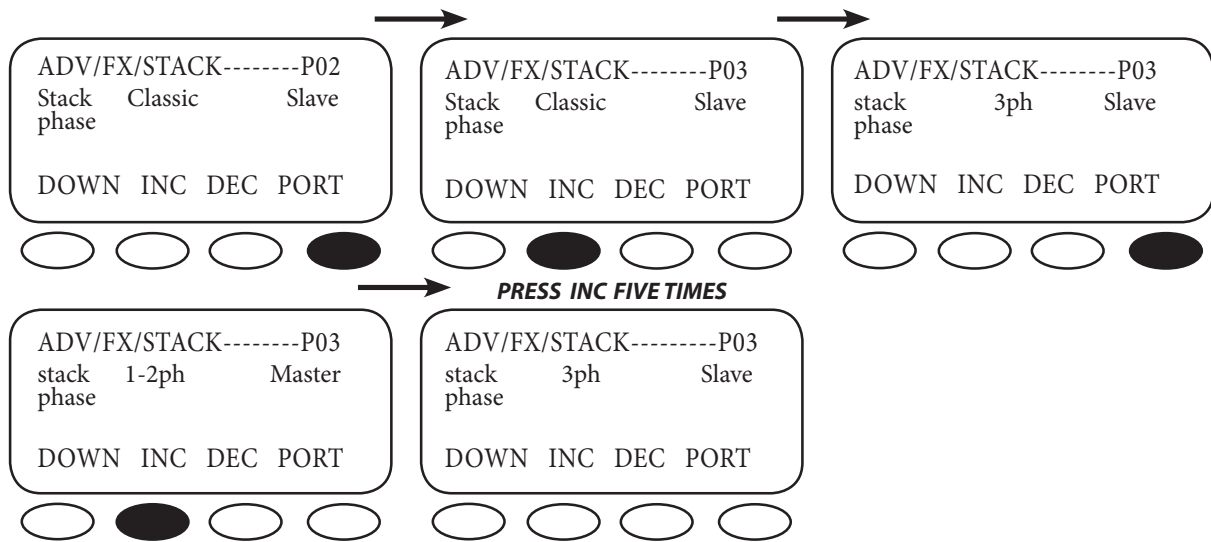

AUXILIARY (AUX) FUNCTIONS

The AUX output provides a 12 VDC, 0.7 ADC max output at the AUX terminals to control DC or AC external loads. Typical loads include signaling a generator system to start, sending a fault alarm signal, or running a small fan to cool the FX.

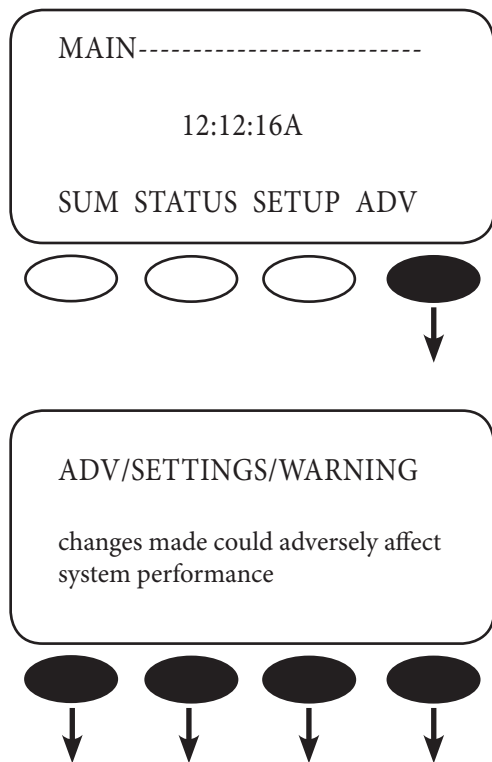

- Press the **<ADV>** soft key.

NOTE: Pressing and holding the first two soft keys at the same time will always bring up the Main Menu screen.

- Push any soft key on the ADV/SETTINGS/WARNING screen and go to the ADV/PASSWORD screen.

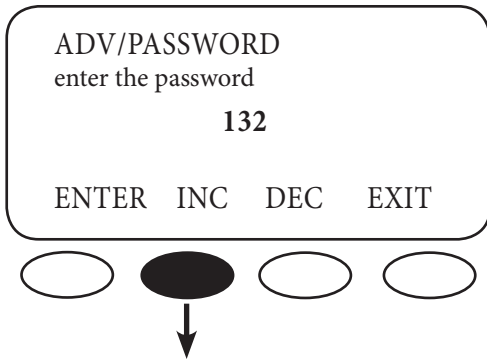

- The screen displays <132>. Press the **<INC>** button until it scrolls to the password 141.

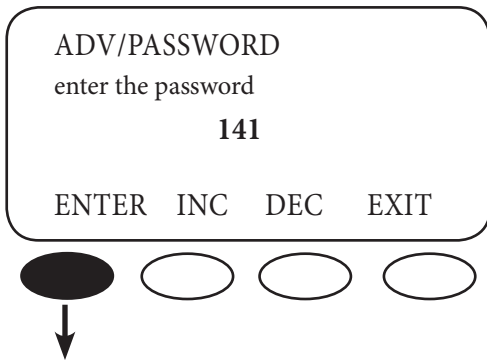

- Push the **<ENTER>** soft key.

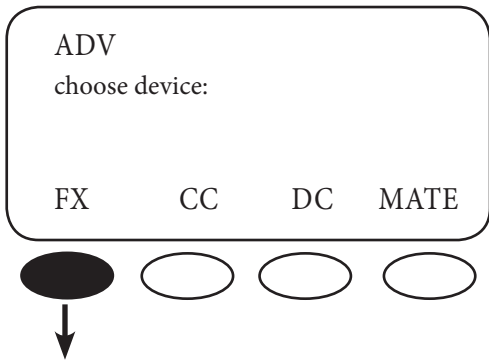

- In the ADV menu, press the **<FX>** soft key.

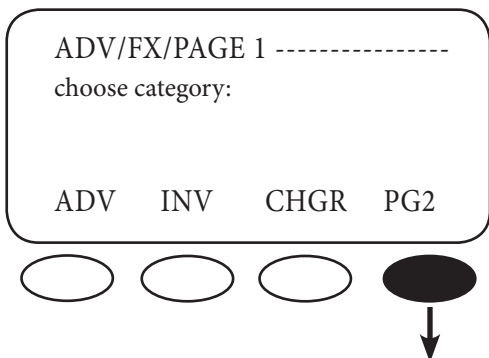

- On the ADV/FX/PAGE 1 screen, press the **<PG2>** soft key and go to the ADV/FX/PAGE2 screen.

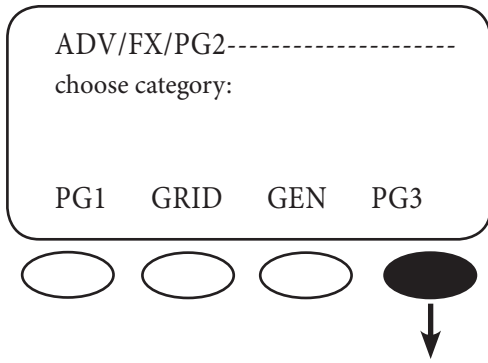

- Press the **<PG3>** soft key which leads to the ADV/FX/PAGE3 screen.

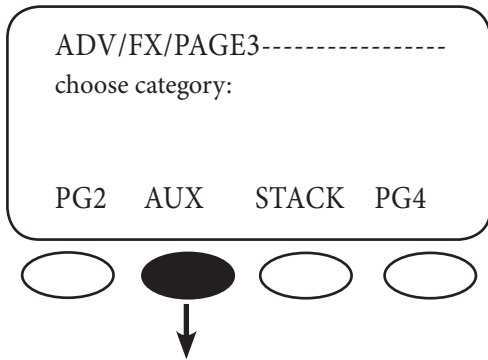

- On the ADV/FX/PAGE3 screen, press the **<AUX>** soft key to adjust the AUX output set points and operation.

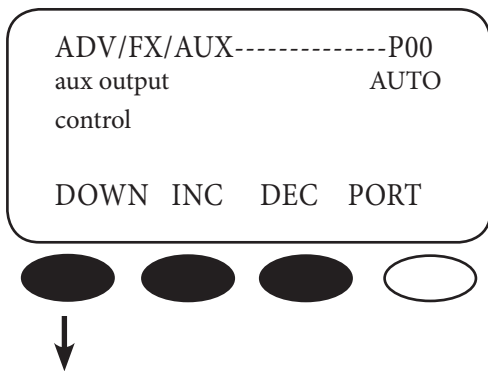

Selecting the **<INC>** or **<DEC>** soft keys changes the mode of the AUX.

- AUTO allows the AUX to perform a selected AUX OUTPUT FUNCTION, determined in the following screens.
- OFF disables the AUX.
- ON activates the AUX regardless of the selected function.

Press the **<DOWN>** soft key to select on an AUX OUTPUT FUNCTION

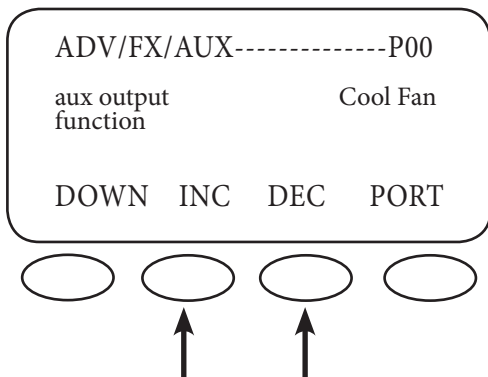

There are nine AUX OUTPUT FUNCTIONS:

- Cool Fan
- Divert DC
- Divert AC
- AC Drop
- Vent Fan
- Fault
- GenAlert
- Load Shed
- Remote

Pressing the **<INC>** or **<DEC>** soft keys changes the stacking phase.

Pressing either the **<INC>** or **<DEC>** soft key will bring up another AUX OUTPUT FUNCTION

LIST OF AUX FUNCTIONS

- **Cool Fan** activates the standard TurboFan which cools the FX during an over temperature condition.
- **Divert DC** and **Divert AC** allows the AUX to divert excess renewable energy to a DC or AC load, respectively. This allows control of energy sources such as wind turbines or hydro-generators. When using Divert AC, the AUX output will shut off if the inverter is overloaded.
- **AC Drop** is activated when an AC power source disconnects from an FX. An indicator, such as an alarm, connected to the AUX warns a user that AC power is no longer available.
- **Vent Fan** provides 0.7 amps to run a 12 VDC fan for removing hydrogen from the battery compartment. Vent Fan can operate automatically when the VENTFAN ON voltage set point is exceeded or it can operate intermittently by adjusting the VENTFAN OFF PERIOD.
- In **Fault** mode, the AUX can send an alarm signal via radio, pager, or telephone device when the FX enters into an error condition. Fault mode can also be used to log error conditions by triggering an event recording device.
- **GenAlert**, through a 12VDC relay, will tell the system to start a two-wire type generator when the battery voltage falls below a certain set point. GenAlert can be adjusted according to the short fall battery voltage, the amount of time spent at this voltage, the recharged voltage and amount of time at this voltage before GenAlert is de-energized.
- **Load Shed** energizes the AUX the reduce the load demand on the batteries and the inverter function, thus acting as a load management system.
- Setting the AUX to **Remote** allows a message sent through the serial Port on the MATE to switch the AUX on and off.

NOTE: that using Advanced Generator Start (AGS) overrides any programmed AUX function.

ADJUSTABLE AUX OUTPUT FUNCTIONS

There are four AUX functions whose settings can be adjusted by the user:

- Diversion
- Vent Fan
- GenAlert
- Load Shed

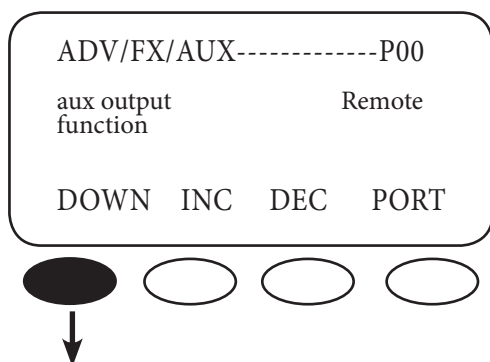

- From the Remote aux output function screen, press the **<DOWN>** soft key

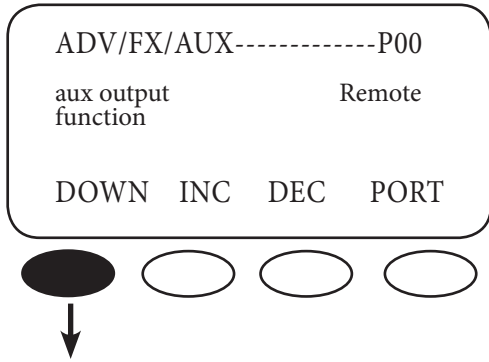

- From the Remote aux output function screen, press the **<DOWN>** soft key. This will bring up the first of several screen used to adjust which ever mode you have chosen for the AUX function.

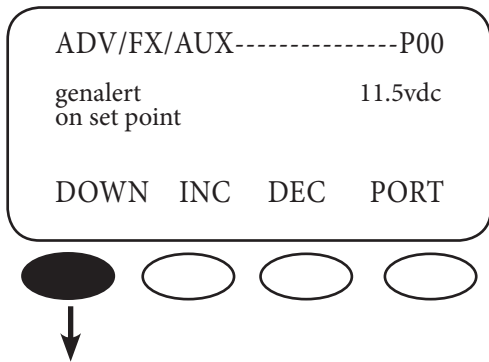

- The genalert on set point screen shows the voltage--whose range is between 10.0 VDC and 14.0 VDC, adjusted with the **<INC>** and **<DEC>** soft keys--at which the AUX is energized in genalert mode. Press the **<DOWN>** soft key to view the genalert on delay screen.

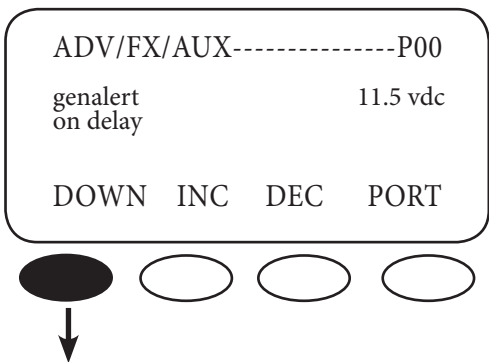

- The genalert on delay is the amount of time the battery voltage must remain below the genalert set point before the AUX is energized. This allows for brief periods of heavy load usage and has a range of 0-240 minutes in one minute increments, adjustable with the **<INC>** and **<DEC>** soft keys. Press the **<DOWN>** soft key to bring up the genalert off set point screen.

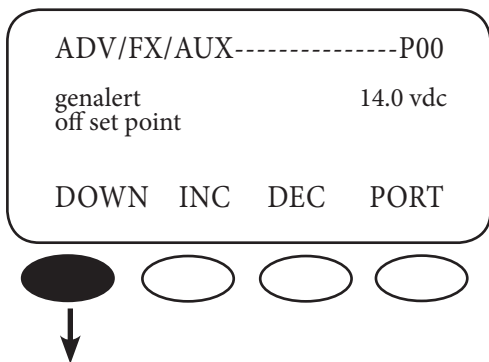

- In genalert mode, the AUX de-energizes when the genalert off set point is reached. This set point's range is between 12.0 VDC and 18.0 VDC and is adjusted in 0.1 VDC increments using the **<INC>** and **<DEC>** soft keys. Press the **<DOWN>** soft key to view the genalert off delay screen.

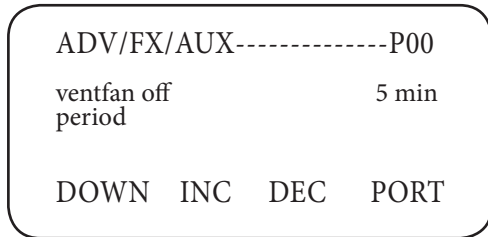
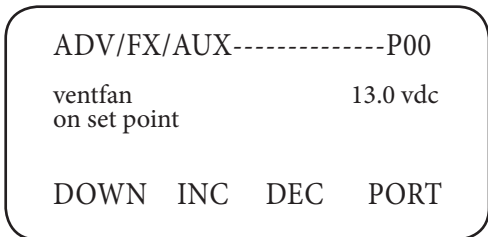
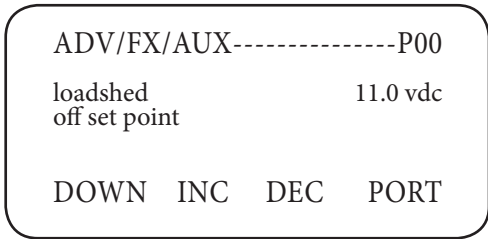
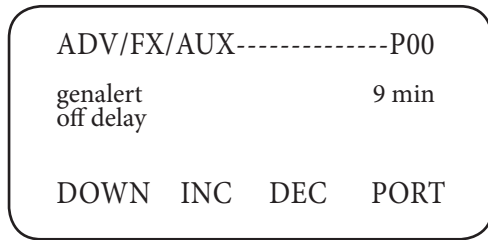

- After a battery has recharged or returned to the genalert off set point, genalert off delay determines the amount of time the generator remains on to assure the battery has been more fully recharged. The user can adjust this time from 0-240 minutes in one-minute increments using the **<INC>** and **<DEC>** soft keys. Press the **<DOWN>** soft key to view the loadshed off set point screen.

- The loadshed off set point is the battery voltage which triggers the AUX to reduce the inverter and battery loads. When the battery voltage drops below this value for three seconds, the AUX powers a DC coil relay to disconnect an AC load. Once triggered, loadshed remains on for at least three minutes. The loadshed off set point is adjustable from 10 VDC-14 VDC in 0.1 VDC increments using the **<INC>** and **<DEC>** soft keys. Press the **<DOWN>** soft key to bring up the ventfan on set point.

- When the AUX is set to ventfan, a fan ventilates a battery enclosure. The ventfan on set point establishes the battery voltage which energizes the AUX and thus the fan for a one-minute period. The voltage setting has a range of 10.0 VDC-16.0 VDC in 0.1 VDC increments using the **<INC>** and **<DEC>** soft keys. Recharging causes batteries to emit mostly hydrogen gas; higher recharging voltages emit more gas. Press the **<DOWN>** soft key to view the ventfan off period screen.

- If a ventilation fan is only needed intermittently, the ventfan off period shuts the fan off for a user-determined time before starting up again for a one-minute period when the battery voltage exceeds the ventfan on set point. This off period can be set from 0-30 minutes in one-minute increments using the **<INC>** and **<DEC>** soft keys. Setting this period to zero will keep the fan running the entire time the battery voltage is high enough to activate the ventfan function. Setting it to five minutes means the fan will run for one minute and then shut off for five minutes until the battery voltage drops and the fan is no longer needed. Press the **<DOWN>** soft key to view the diversion on set point screen.

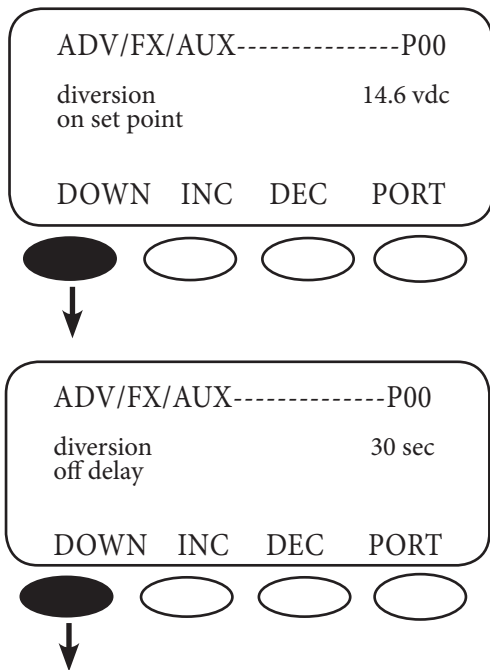

- After deciding on Divert DC or Divert AC in the AUX output function screen, use the diversion on set point screen to choose the voltage which will activate this function. This value can range from 12.0 VDC-16.0 VDC and can be adjusted in 0.1 VDC increments using the **<INC>** and **<DEC>** soft keys. Press the **<DOWN>** soft key to view the diversion off delay screen.

- The diversion off relay determines how long the AUX will be energized after the battery voltage which caused the diversion falls below the diversion on set point. This relay can range from 0-240 seconds in one-second increments as adjusted with the **<INC>** and **<DEC>** soft keys.

BATTERY CHARGING INSTRUCTIONS

Keeping your battery bank energized is very important. Although a battery bank can last for many years if properly cared for, it can also be ruined in a short period of time if neglected.

Battery Charging Set Points

To preserve your batteries, always follow your battery manufacturer's recommendations using the following information:

- Absorb Voltage
- Float Voltage
- Equalize Voltage
- Recommended Depth of Discharge (DOD) of the batteries

These Absorb, Float and Equalize voltage set points should be programmed into the FX through the MATE (see *MATE User Manual*).

MAINTENANCE

Please contact OutBack Power Systems Technical Services for any FX repairs due to malfunctions or damage.

For routine, user-approved maintenance:

- Disconnect all circuit breakers and related electrical connections before doing any cleaning or adjustments.
- Solar modules may produce hazardous voltages when exposed to light; cover them with opaque material before servicing any connected equipment.
- If a remote or automatic generator start system is used, disable the automatic starting circuit and/or disconnect the generator from its starting battery while servicing it to prevent starting while servicing.

12VDC system	DEFAULT	MINIMUM	MAXIMUM
Float Voltage	13.6	12	15
Absorb Voltage	14.4	13	16
EQ Voltage	14.4 ▶	14	17 ▶ (24VDC Grid-Tie is 29.2 default)
ReFloat	12.5	11	13
LBCO	10.5	9	12
LBCI	12.5	10	14
Sell RE	13.0	10	15
GenAlert			
Off Set Point	14	12	18V
On Set Point	11	10	14V
Load Shed off Set Point	11	10	14V
Vent Fan ON set Point	13	10	16V
Diversion On Set Point	14.6	12	16V
Absorb Time	1.0 hours	0.0 hours	24.0 hours
EQ Time	1.0 hours	0.0 hours	24.0 hours
Float Time	1.0 hours	0.0 hours	24.0 hours
AC2/Gen Transfer Delay (Cycles for AC)	60 cycles* *20 for Grid-Tie	0 cycles	240 cycles
Search	6	0	50
Grid Lower Limit	108	40	115
Export Grid Lower Limit Only	208	80	220
Grid Upper Limit (USA)	140	130	150
Grid Upper Limit (Export)	270	250	300
Grid Connect Delay	.5 min	.2 MIN	15.0 min
Drop or Use	USE	N/A	N/A
Charger Off/Auto/On	AUTO		
Aux Output Option	COOL FAN		
Gen Alert On Delay	4 min	0 min	240 min
Gen Alert Off Delay	9 min	0 min	240 min
Vent Fan Off Delay	5 min	0 min	30 min
Gen Window Lower Limit 60 Hz	108	40	115
Export Only	208	80	220
Gen Upper Window Limit 60 Hz	140	130	150v
Export Only	270	250	300
Ac 1/Grid Transfer Delay (Cycles of AC)	6	0	240
Set AUX Control	AUTO		
Search Pulses	8	2	20
Search Pulse Spacing (Cycles AC)	60	4	120
Stacking Phase	1 or 2 Phase		
InPut Select	Master Gen		
Charge Rates for Vented 24 & 48 VDC	18 Amp AC		20 Amp AC
Charge Rates for Vented 12 VDC	12 Amp AC	0 Amp AC	14 Amp AC
Charge Rates for Sealed 24 & 48 VDC	10 Amp AC	0 Amp AC	14 Amp AC
Charge Rates for Sealed 12 VDC	10 Amp	0 Amp AC	12 Amp AC
Grid Input Settings			
Set AC Input Size	28 Amp		
Mobile	48 Amp	5 Amp	30 Amp
Non-Mobile (US)	28 Amp	5 AMP	60 Amp
Export	50 Amp	5 Amp	30 Amp
GT			
Gen Input Settings			
Mobile	28		30
Non-Mobile (US)	48	2	60
Export	28	2	30
GT	50	2	
GT	120		125V
Set VAC (US)	230	110	240V
Export		210	

E models are one-half of these values

Correction Factor
 24 VDC: Multiply 12VDC values by 2
 32 VDC: Multiply 12 VDC values by 2.64
 48 VDC: Multiply 12VDC values by 4

FX Default Values (subject to change with FX upgrades)

WARRANTY

OutBack Power Systems Two Year Limited Warranty

OutBack Power Systems Inc. warrants that the products it manufactures will be free from defects in materials and workmanship for a period of two (2) years subject to the conditions set forth below.

The limited warranty is extended to the original user and is transferable. The limited warranty term begins on the date of invoice to the original user of the product. The limited warranty does not apply to any product or part thereof damaged by a) alteration or disassembly, b) accident or abuse, c) corrosion, d) lightning, e) reverse polarity, f) repair or service provided by an unauthorized repair facility, g) operation or installation contrary to instructions pertaining to the product.

OutBack Power Systems' liability for any defective product or any part thereof shall be limited to the repair or replacement of the product, at OutBack Power Systems' discretion. OutBack Power Systems does not warrant or guarantee the workmanship performed by any person or firm installing its products.

THIS LIMITED WARRANTY GIVES YOU SPECIFIC LEGAL RIGHTS, AND YOU MAY ALSO HAVE OTHER RIGHTS THAT VARY FROM STATE TO STATE (OR JURISDICTION TO JURISDICTION). OUTBACK POWER SYSTEMS' RESPONSIBILITY FOR MALFUNCTIONS AND DEFECTS IN HARDWARE IS LIMITED TO REPAIR AND REPLACEMENT AS SET FORTH IN THIS LIMITED WARRANTY STATEMENT. ALL EXPRESS AND IMPLIED WARRANTIES FOR THE PRODUCT, INCLUDING BUT NOT LIMITED TO ANY IMPLIED WARRANTIES OF AND CONDITIONS OF MERCHANTABILITY AND FITNESS FOR A PARTICULAR PURPOSE, ARE LIMITED IN DURATION TO THE LIMITED WARRANTY PERIOD SET FORTH ABOVE AND NO WARRANTIES, WHETHER EXPRESS OR IMPLIED, WILL APPLY AFTER SUCH PERIOD. SOME STATES (OR JURISDICTIONS) DO NOT ALLOW LIMITATIONS ON HOW LONG AN IMPLIED WARRANTY LASTS, SO THE ABOVE LIMITATION MAY NOT APPLY TO YOU.

OUTBACK POWER SYSTEMS DOES NOT ACCEPT LIABILITY BEYOND THE REMEDIES SET FORTH IN THIS LIMITED WARRANTY STATEMENT OR LIABILITY FOR INCIDENTAL OR CONSEQUENTIAL DAMAGES, INCLUDING WITHOUT LIMITATION ANY LIABILITY FOR PRODUCTS NOT BEING AVAILABLE FOR USE. SOME STATES (OR JURISDICTIONS) DO NOT ALLOW THE EXCLUSION OR LIMITATION OF INCIDENTAL OR CONSEQUENTIAL DAMAGES, SO THE ABOVE EXCLUSION OR LIMITATION MAY NOT APPLY TO YOU.

During the two year period beginning on the invoice date, OutBack Power Systems will repair or replace products covered under this limited warranty that are returned to OutBack Power Systems' facility or to an OutBack Power Systems authorized repair facility, or that are repaired on site by an OutBack Power Systems authorized repair technician. To request limited warranty service, you must contact OutBack Power Systems at 360-435-6030 within the limited warranty period. If limited warranty service is required, OutBack Power Systems will issue a Return Material Authorization (RMA) Number. Mark the outside of the package with the RMA number and include a copy of the purchase invoice in the package. You must ship the products back to OutBack Power Systems in their original or equivalent packaging, prepay shipping charges, and insure the shipment or accept the risk of loss or damage during shipment. OutBack Power Systems will ship the repaired or replacement products to you freight prepaid if you use an address in the continental United States, where applicable. Shipments to other locations will be made freight collect.

PRODUCT REGISTRATION

Your purchase of an OutBack Power Systems product is an important investment. Registering your products will help us maintain the standard of excellence you expect from us in terms of performance, quality and reliability.

Please take a moment to register and provide us with some important information.

NAME: _____ E-MAIL: _____

ADDRESS: _____ SOLD BY: _____

CITY: _____ INSTALLER: _____

STATE: _____ ZIP CODE: _____ PURCHASE DATE: _____

COUNTRY: _____ MODEL NUMBER: _____

TELEPHONE NUMBER: _____ SERIAL NUMBER: _____

Circle all that apply:

- | | | |
|---|---|---|
| <input type="checkbox"/> Off-Grid Installation | <input type="checkbox"/> Residential Installation | <input type="checkbox"/> North America Location |
| <input type="checkbox"/> Utility Connected Installation | <input type="checkbox"/> Commercial Installation | <input type="checkbox"/> Other _____ |

EXTENDED WARRANTY APPLICATION (U.S. AND CANADA ONLY)

OutBack Power Systems offers an optional three year extension to the standard two year limited warranty. Purchase of extended warranty coverage is available on products listed below provided conditions shown are met. Extended warranty coverage must be purchased within 90 days of the original sale of the product covered.

PRODUCT COST	REQUIRED SURGE PROTECTION	EXTENDED WARRANTY
Any FX Series Inverter/Charger	AC Input; AC Output, DC Input	\$300.00
OutBack Charge Controller	DC Input; DC Output	\$100.00
MATE	NA	\$50.00
HUB 4	NA	\$35.00
HUB 10	NA	\$50.00

Product Covered	Serial Number	Quantity	Extended Warranty Cost
_____	_____	_____	_____
_____	_____	_____	_____
_____	_____	_____	_____
_____	_____	_____	_____
			Total _____

Send check or money order payable to OutBack Power Systems. Washington residents please include 8.5% sales tax. Include a completed copy of this application and send to:

OutBack Power Systems
 Extended Warranty Program
 19009 62nd Ave NE • Arlington, WA 98223 USA



19009 62nd Avenue NE
Arlington, WA 98223 USA
(+1) 360.435.6030

European Sales Office
Barcelona, ESPAÑA
(+34) 600.843.845

www.outbackpower.com

900-0084-01-00 REV A